

FUN*da*MENTALS of Design

Error Budgets

Alexander Slocum

Pappalardo Professor of Mechanical Engineering

Massachusetts Institute of Technology

slocum@mit.edu

November 29, 2012

Error Budgets

Topics

- Background
- Error Budgets: Why?, What?, How?
- HTMs
- Initial Error Allowances
- Structural Loops
- Stick Figures
- Error Motions
- Rotary Motion Estimates
- Linear Motion Estimates
- Error Budget Spreadsheets
- Principles in Support of Error Budgeting

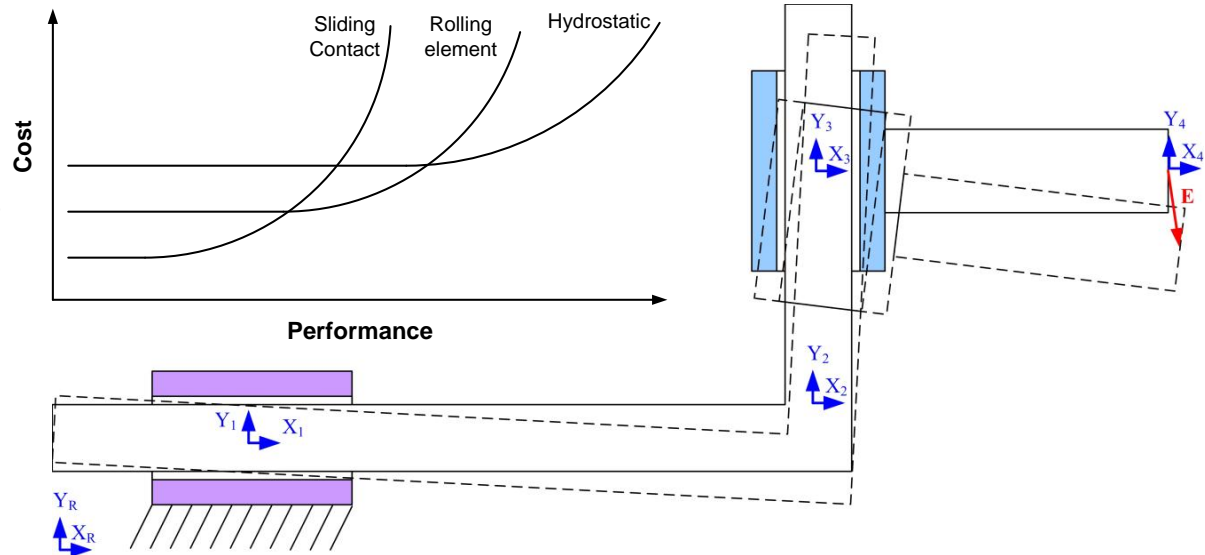
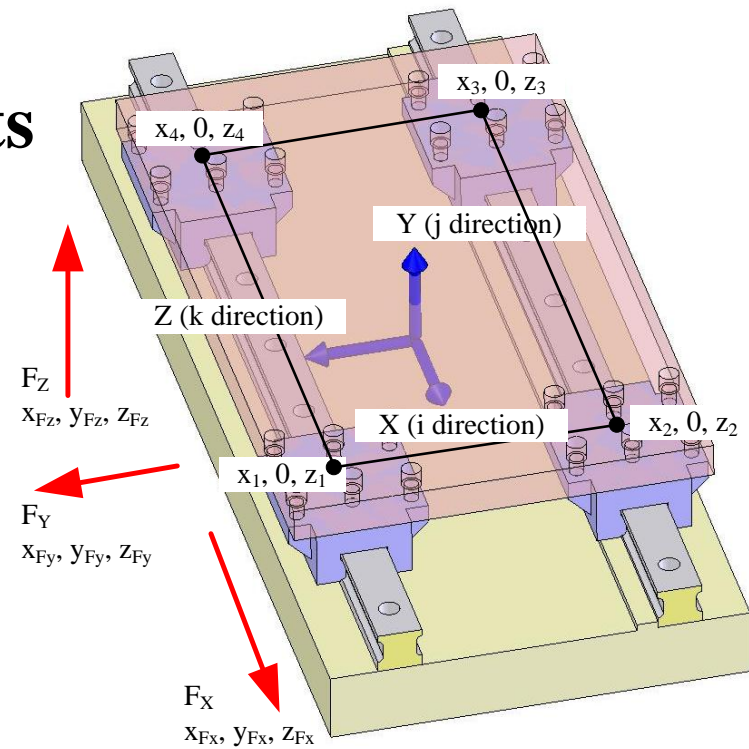

Background:

Find the time to immerse yourself in at least these Books

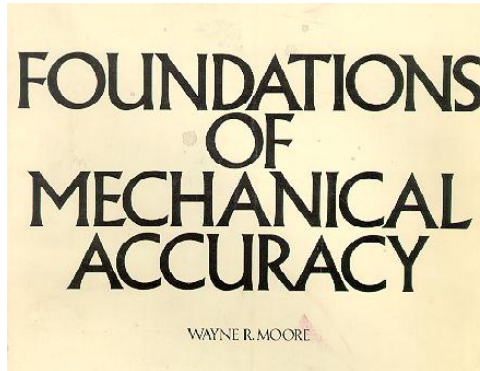

FUNdaMENTALS of Design
<http://web.mit.edu/2.75/resources/FUNdaMENTALS.html>

Free on-line text!

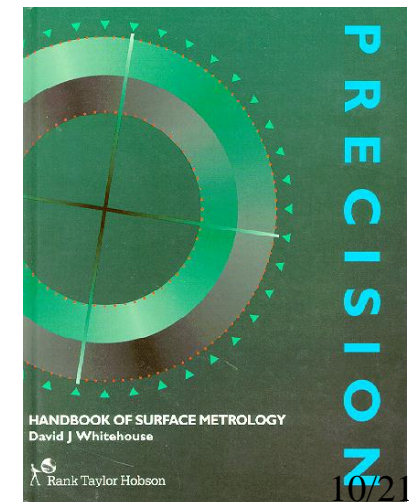
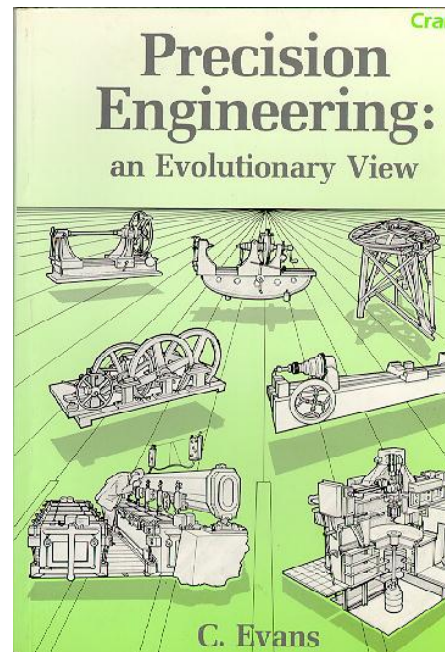
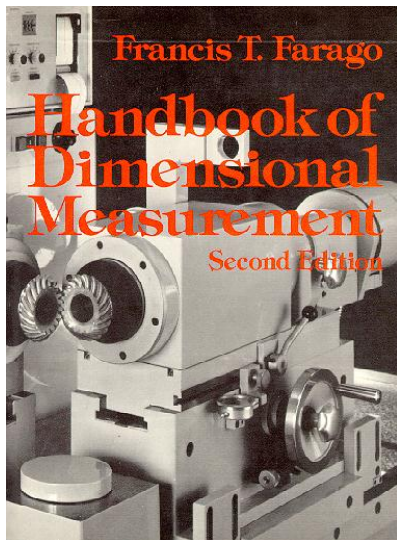
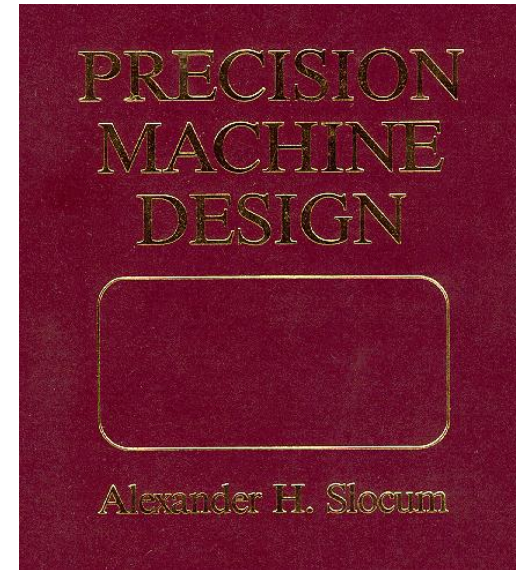

Error Budgets: *Why?*

- A fast low cost tool to evaluate concepts before spending the time (\$) to solid model and FEA (which will not catch geometric errors...), because:
 - Nothing is perfect
 - Need to predict accuracy and repeatability of machine
 - Need to better predict loads/life of bearings!
- Start with basics
 - Structural loop
 - Stick figures
 - Error Budget Spreadsheets
 - Homogeneous Transformation Matrices
 - Modeling Error Motions

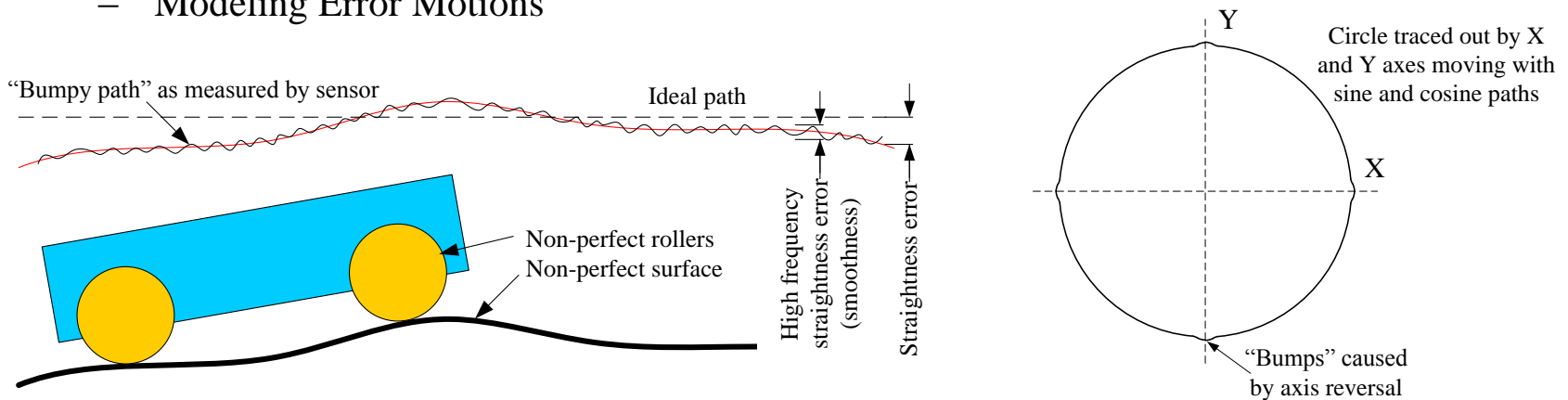

Error Budgets: *What?*

- Four primary types of error include
 - Geometric
 - Load-induced
 - Thermal
 - Process
- For high precision machines, the magnitude of each will be about equal if there is a balanced allocation of resources
 - During the concept phase, develop the geometric-based error budget to be 4X better than required for the entire machine
 - Use Homogeneous Transformation Matrix-based spreadsheets
 - This lets you investigate the overall geometry (and spacing) of elements
 - Next, use solid models and FEA to ensure load-induced and thermal deflections are within limits
- Error budgets are useful for predicting the accuracy and repeatability of a machine
 - They can also be useful for helping to predict misalignment loads on bearings

Error Budgets: *How?*

Homogeneous Transformation Matrices

- HTMs help to model how motions in one link in a serial chain reflect through the chain

$$\begin{bmatrix} X_N \\ Y_N \\ Z_N \\ 1 \end{bmatrix} = {}^N T_{N+1} \begin{bmatrix} X_{N+1} \\ Y_{N+1} \\ Z_{N+1} \\ 1 \end{bmatrix} \quad {}^N T_{N+1} = \begin{bmatrix} O_{ix} & O_{iy} & O_{iz} & P_x \\ O_{jx} & O_{jy} & O_{jz} & P_y \\ O_{kx} & O_{ky} & O_{kz} & P_z \\ 0 & 0 & 0 & 1 \end{bmatrix}$$

- Each column represents the direction cosines of the rotated axes
 - To avoid confusion about order of rotation, one HTM per axis of rotation
 - For small angular error motions, order not important
 - The spreadsheet does the math, so you do not have to worry about it
 - Just use good modeling technique

- Limitations: open kinematic chains
 - Methods for use with closed chains(e.g., kinematic couplings)

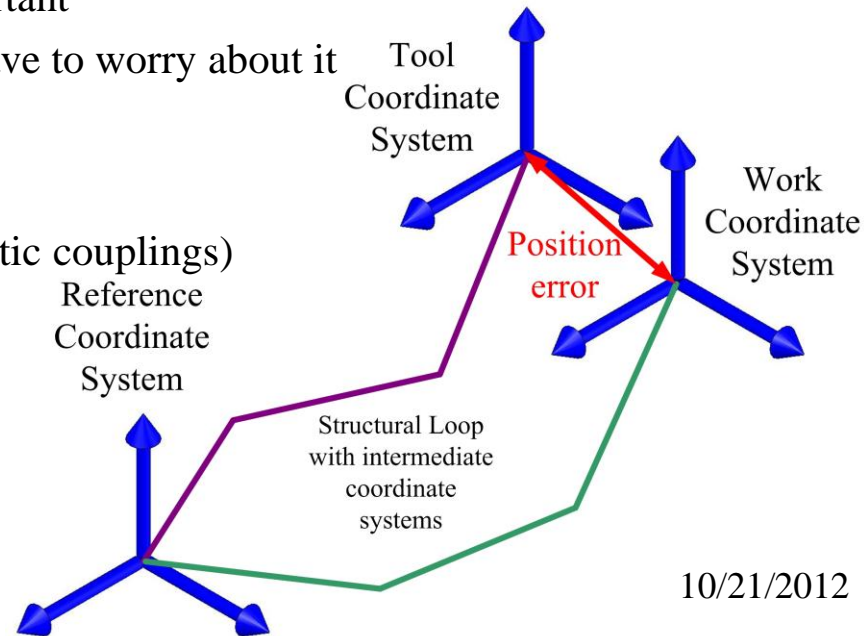

Homogeneous Transformation Matrices

- HTMs in particular help model “Abbe errors”

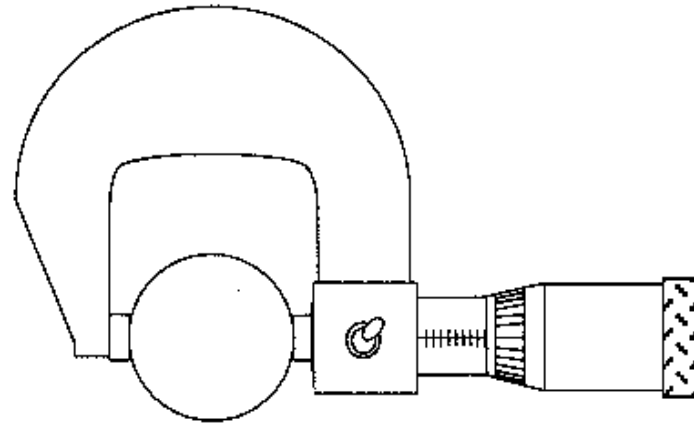
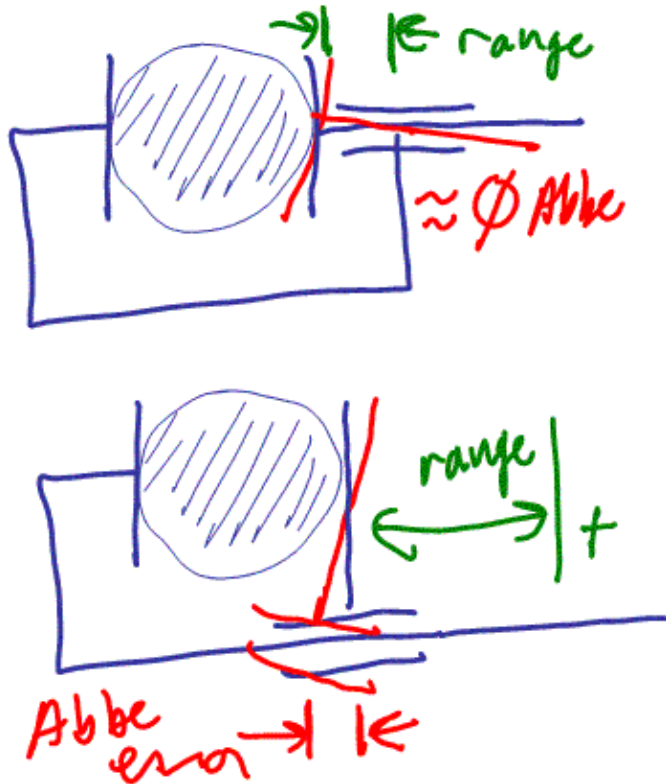

Initial Error Allowances

- The first issue with a precision machine is to understand the overall requirements:
 - Operating conditions
 - What are the dominant physics?
 - Accuracy, repeatability, resolution...
- Consideration of the dominant parameters enable 1st-order apportioning of error amongst axes & components
 - *This is a critical catalyst for creating viable strategies and concepts*
- This can be done for the RANDOM and Systematic cases!

Axis_error_apportionment_estimator.xls									
To apportion errors between types and axes									
By Alex Slocum, last modified 10/12/06 by Alex Slocum									
Enter numbers in BOLD , Results in RED									
Number of axes	3	N							
Total allowable error (microns)	10	dtot							
				Apportion of error within each axis (amount allocated to X, Y, Z direction) TBD by sensitive directions					
				Bearings (fb)	Structure (fs)	Actuator (fa)	Sensor (fs)	Cables (fc)	
Source of error	Factor (f)	Apportion of error (dtot/f)	Apportion of error per axis	1	1	1	1	0.2	
Geometric (fg)	1	2.500	0.833	0.198	0.198	0.198	0.198	0.040	
Thermal (ft)	1	2.500	0.833	0.198	0.198	0.198	0.198	0.040	
Load-induced (deflection) (fl)	1	2.500	0.833	0.198	0.198	0.198	0.198	0.040	
Process (fp)	1	2.500	0.833	0.198	0.198	0.198	0.198	0.040	

Structural Loops

- The *Structural Loop* is the path that a load takes from the tool to the work
 - It contains joints and structural elements that locate the tool with respect to the workpiece
 - It can be represented as a stick-figure to enable a design engineer to create a *concept*
 - Subtle differences can have a HUGE effect on the performance of a machine

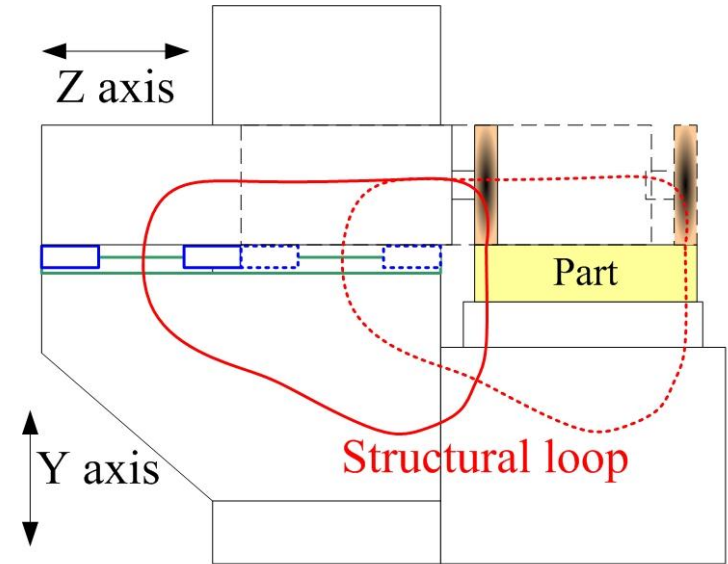

Constant Stiffness Design

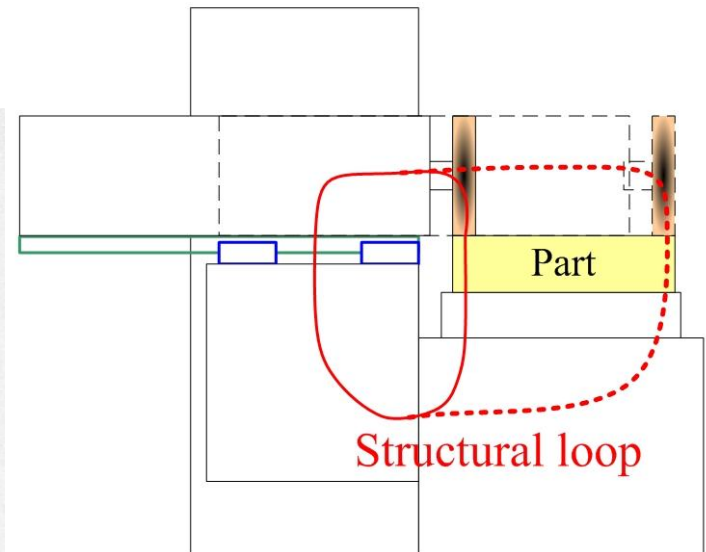
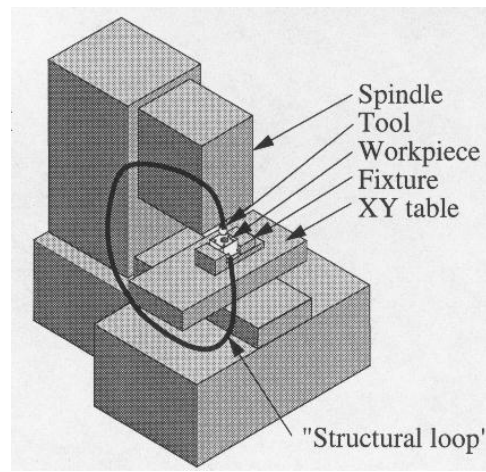
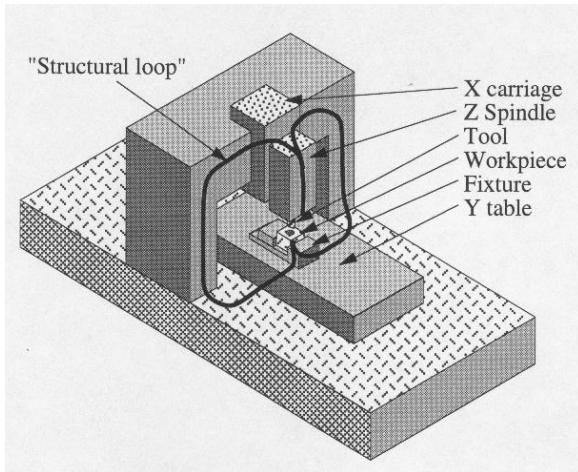

Maximum Stiffness Design

Structural Loops

- *The product of the length of the structural loop and the characteristic manufacturing and component accuracy (e.g., parts per million) is indicative of machine accuracy (ppm)*
 - The product of the structural loop length, CTE and temperature variation (goodness of the environment) is an indicator of machine performance
 - Long-open *structural loops* have less stiffness and less accuracy than closed structural loops
 - However, closed loop machines can be more difficult to design and build

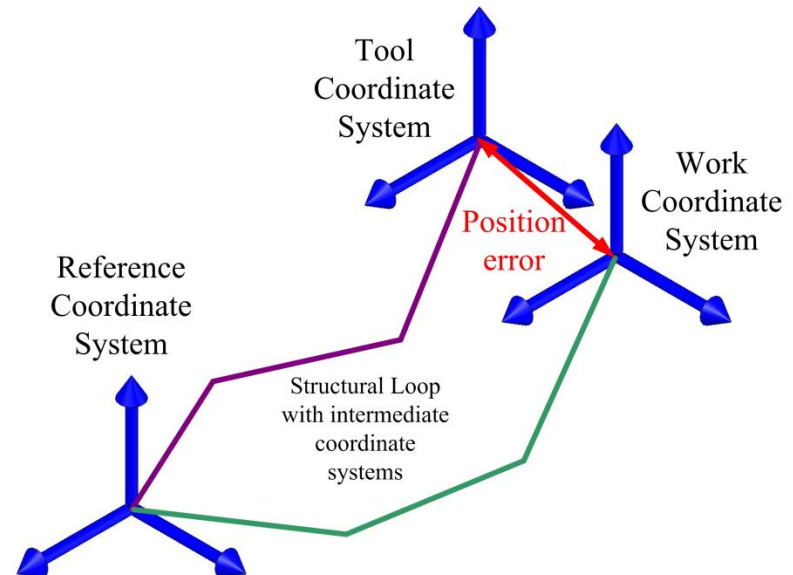
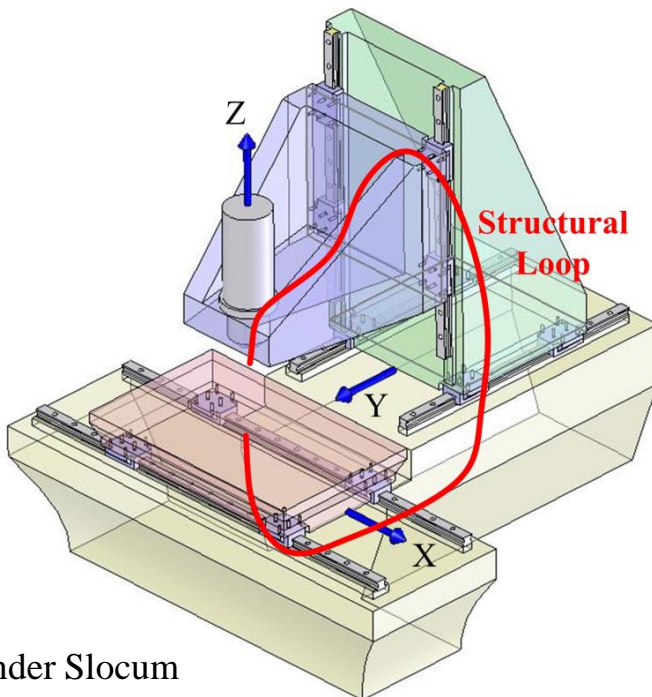

Structural Loops

- When the first sketch of the structure is made:
 - Arrows indicating forces, moments, and power should also be sketched
 - The path of how these forces and moments flow from the point of action to the point of reaction, shows the *structural loop*
- A sketch of the structural loop is a great visual design aid
 - A closed structural loop indicates high stability and the likely use of symmetry to achieve a robust design
 - An open structural loop is not bad, it means “proceed carefully”
 - Remember Aesop’s fables & “The Oak Tree and the Reeds”

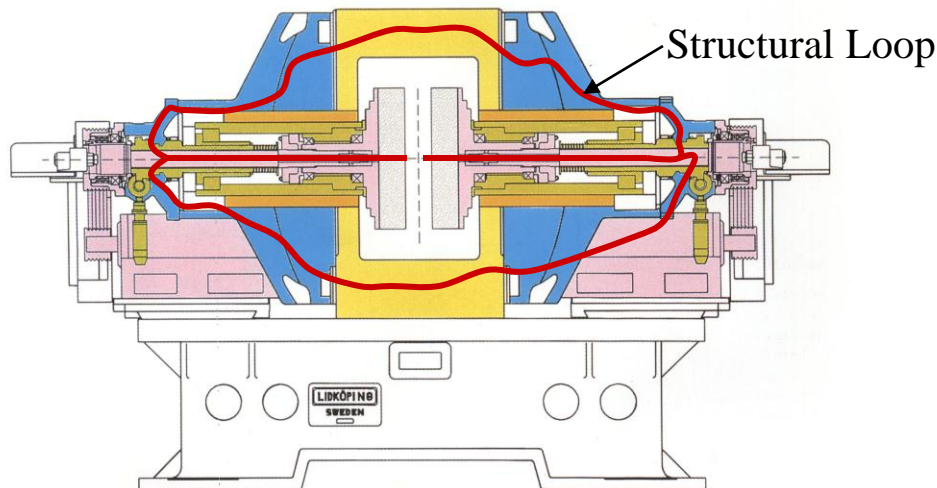
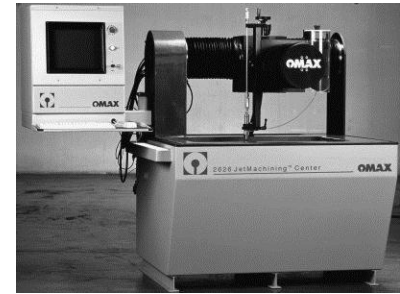

Duplex Grinder
LIDKÖPING DG 500



Stick Figures

- Stick figure:
 - The sticks join at centers of stiffness, mass, friction, and help to:
 - Define the sensitive directions in a machine
 - Locate coordinate systems
 - Set the stage for error budgeting
 - The designer is no longer encumbered by cross section size or bearing size
 - It helps to prevent the designer from locking in too early on a concept
- Error budget and preliminary load analysis can then indicate the required stiffness/load capacity required for each “stick” and “joint”
 - Appropriate cross sections and bearings can then be deterministically selected

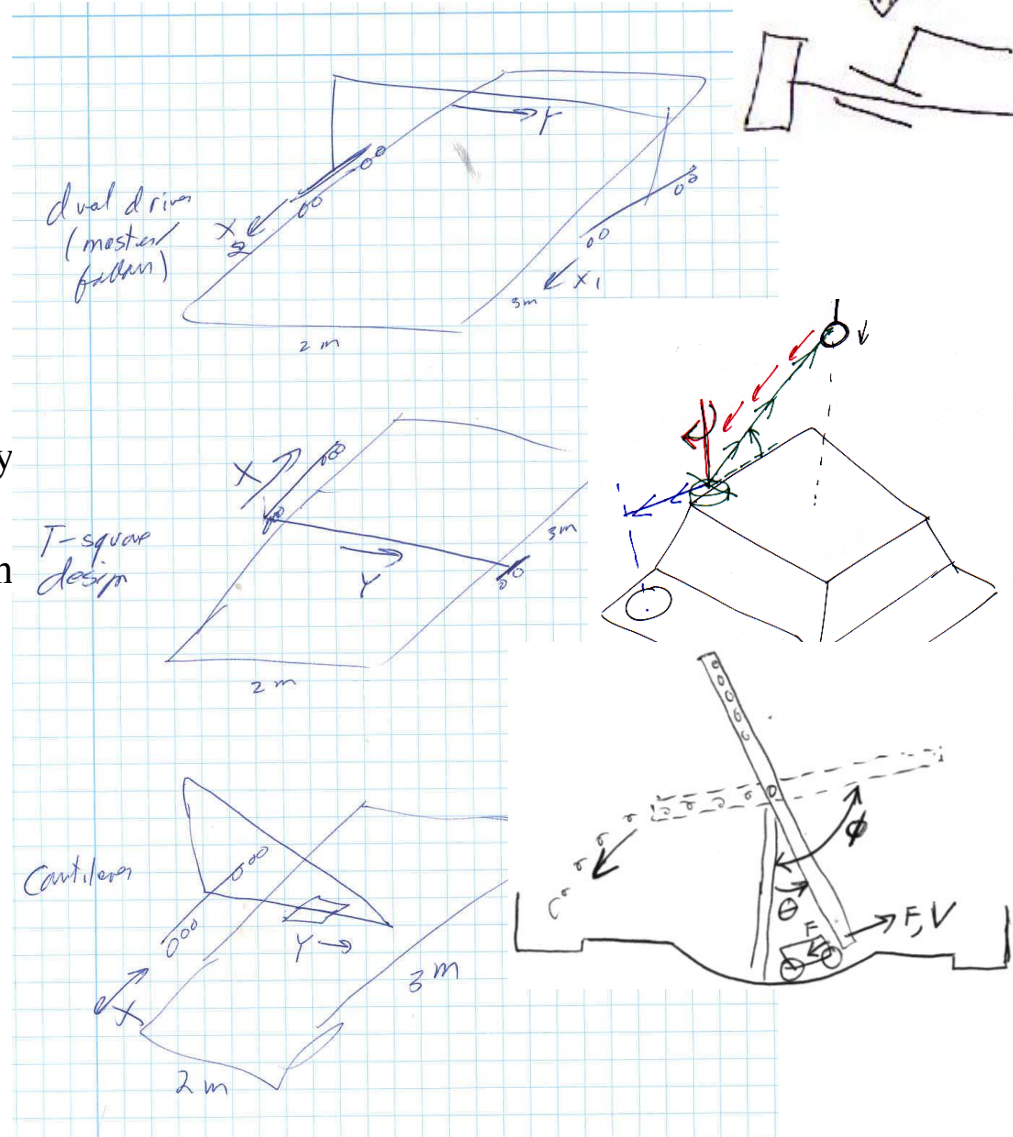

Error Motions

- Bearings are not perfect, and when they move, errors occur in their motion
 - Accuracy standards are known as *ABEC* (Annular Bearing Engineers Committee) or *RBEC* (Roller Bearing Engineers Committee) of the American Bearing Manufacturers Association (ABMA)
 - ABEC 3 & RBEC 3 rotary motion ball and roller bearings are common and low cost
 - ABEC 9 & RBEC 9 rotary motion ball and roller bearings are used in high precision machines
 - The International Standards organization (ISO) has a similar standard (ISO 492)
- An error budget is used to keep track of all the error motions in a machine
 - Remember Abbe and sine errors and how they can amplify bearing angular errors!

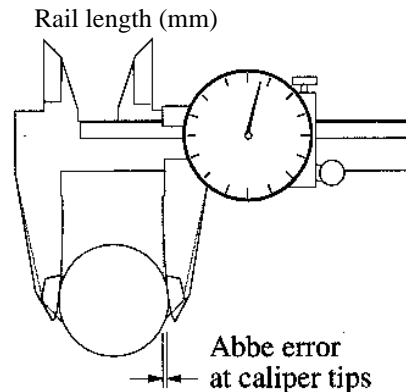
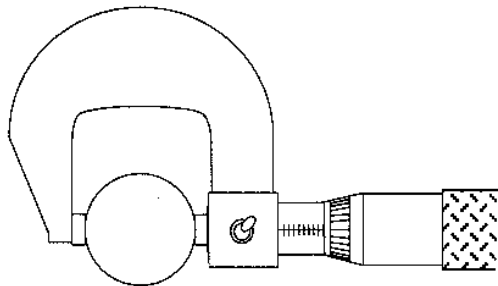
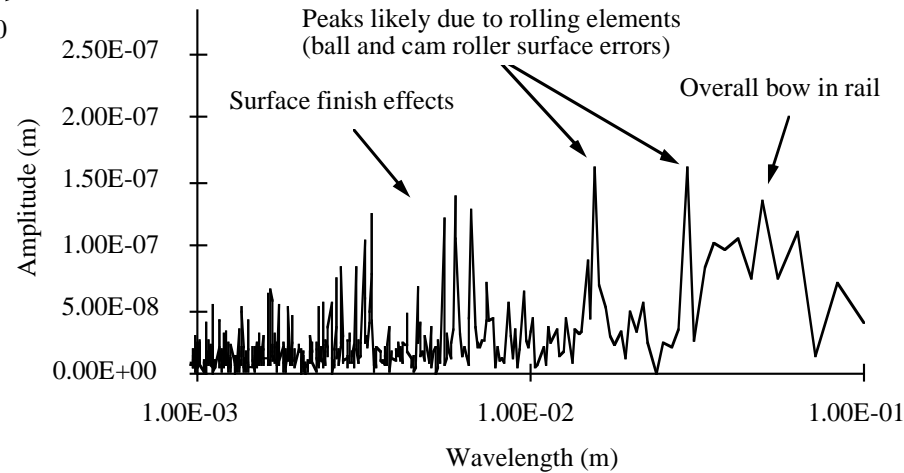
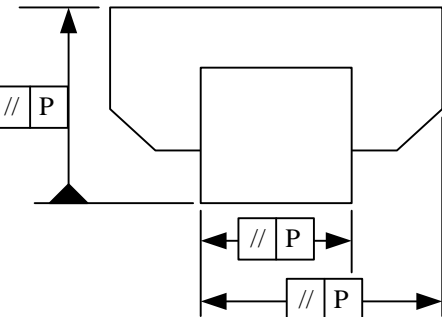
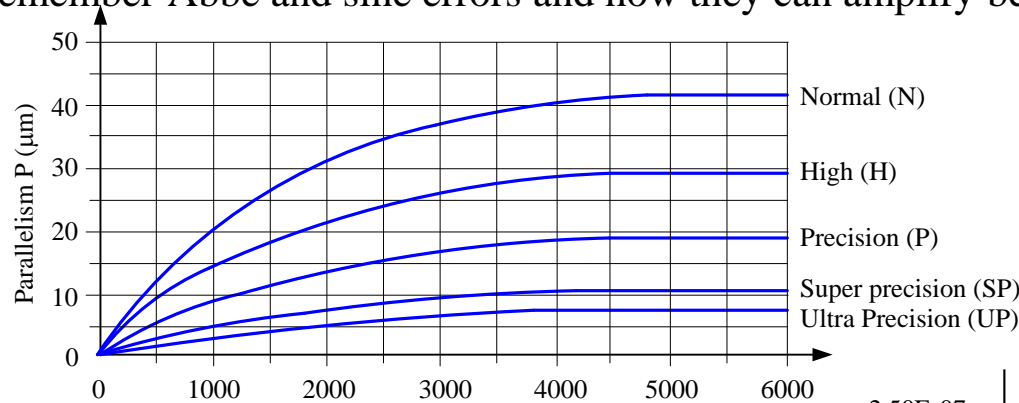

Error Motions: *Rotary Bearings*

- Standards exist for describing and measuring the errors of an *axis of rotation*:
 - Axis of Rotation: Methods for Specifying and Testing, ANSI Standard B89.3.4M-1985
- The digital age depends on hard disc drives which exist because of accurate repeatable rotary motion bearings
 - Radial, Axial, and Tilt error motions are of concern
- Precision Machine Designers measure error motions and use *Fourier transforms* to determine what is causing the errors...

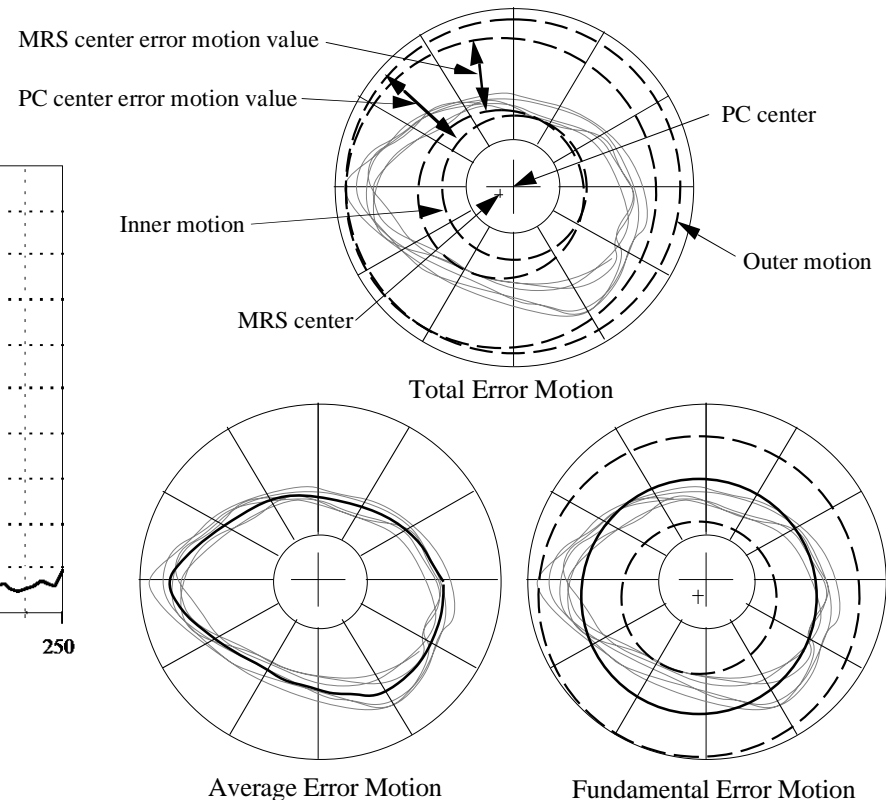
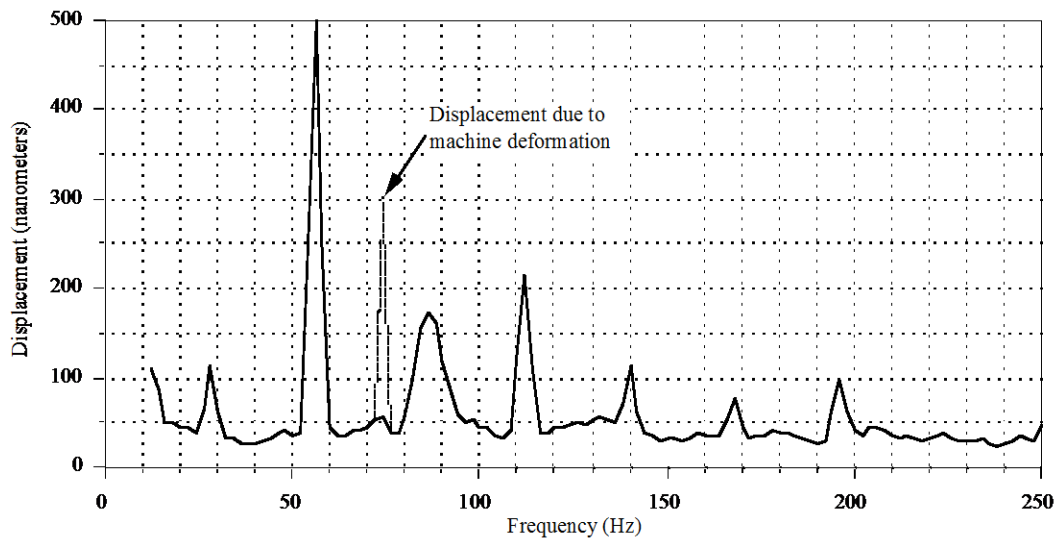

Error Motions: *Rotary Motion Estimates*

- Rotary bearings usually only come with an overall quality rating (e.g., ABEC 9, ISO 5)
 - The rating indicates ID and OD tolerance of the bearing
 - *The accuracy of the supported element (e.g., shaft) axis of rotation is usually dominated by the accuracy of the bore, shaft, alignment, and clamping method.*
 - Mel Liebers at Professional Instruments [MLiebers@airbearings.com] has tremendous insight on bearing measurement and mounting
 - As he points out, screw-actuated locknuts can also be used to preload a bearing and deform a shaft to correct for errors and thus achieve greater accuracy
 - » E.g. <http://www.ame.com/>
- As a first order estimate, assume the root square sum of the bore and shaft roundness are representative of the radial accuracy of the supported shaft.
 - Similar for axial accuracy
- Tilt accuracy can be estimated by radial accuracy divided by spacing between bearing sets
 - If just a single bearing set is used, tilt accuracy can be estimated by the flatness of the bearing mount (bore) divided by the bearing pitch diameter

Error Motions: *Linear Bearings*

- Error motions of a carriage supported by a kinematic arrangement of bearings (exact constraint) can be determined "exactly"
- Error motions of a carriage supported by an elastically averaged set of bearings can be estimated by assuming the bearings act in pairs
- Calculations can be done using the "running parallelism" error in for supplier
 - Running parallelism number is usually a systematic (repeatable) error
 - Random error motion may be 10% of the running parallelism

Horizontal Straightness: δ_y Assume all bearings move horizontally

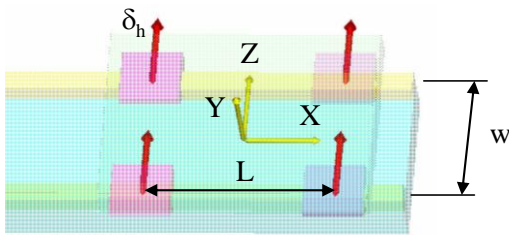

Vertical Straightness: δ_z Assume all bearings move vertically

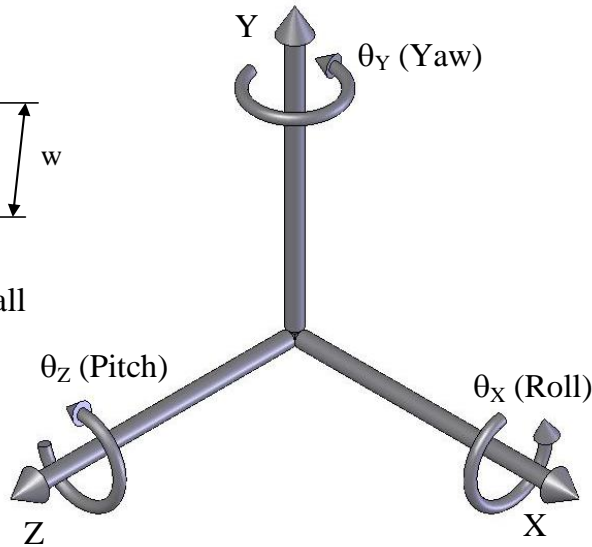
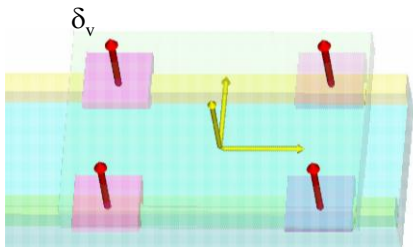

Roll: ϵ_x Assume all bearings on each rail move vertically in an opposite direction

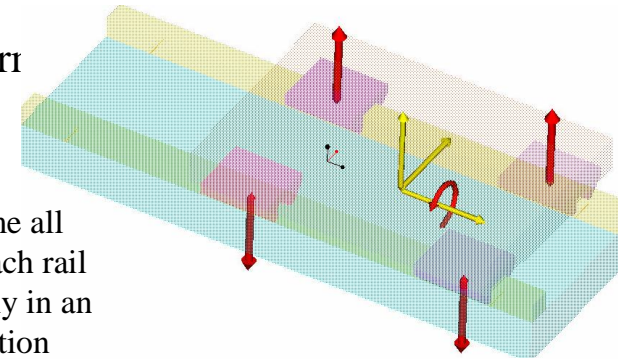

Pitch: ϵ_z Assume front and rear bearing pairs move in opposite vertical directions

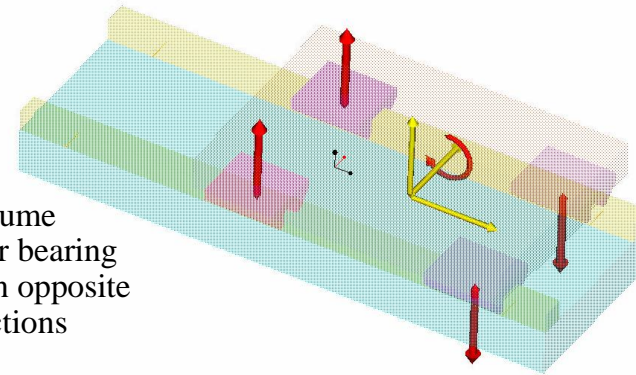

Yaw: ϵ_y Assume front and rear bearing pairs move in opposite horizontal directions

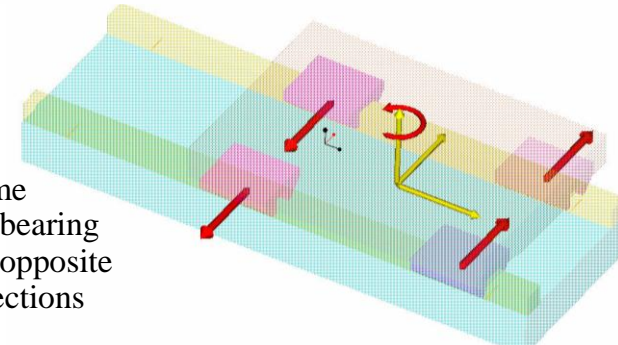

Error Motions: Linear Motion Estimates

Microsoft Excel - ErrorGainSpreadsheet two axis example.xls

File Edit View Insert Format Tools Data Window Help Adobe PDF

M7 fx

Worksheet to estimate error motions of axes supported by linear motion guides
 Enters numbers in **BOLD**, Results in **RED**. NOTE: BE CONSISTENT WITH UNITS

	A	B	C	D	E	F	G	H	I	J	K
1	Worksheet to estimate error motions of axes supported by linear motion guides										
2	Enters numbers in BOLD, Results in RED. NOTE: BE CONSISTENT WITH UNITS										
3											
4	X1 axis										
5	X axial sapcing, A (m)	0.25									
6	Z width spacing, B (m)	0.25									
7	Bearing block 1 running parallelism errors (microns)		bearing numbers (looking down along Y1 axis)								
8	dy_1 (microns)	5									
9	dz_1 (microns)	5	3		2						
10	Bearing block 2 running parallelism errors (microns)										
11	dy_2 (microns)	5	4		1						
12	dz_2 (microns)	5									
13	Bearing block 3 running parallelism errors (microns)										
14	dy_3 (microns)	5									
15	dz_3 (microns)	5									
16	Bearing block 4 running parallelism errors (microns)										
17	dy_4 (microns)	5									
18	dz_4 (microns)	5									
19	Expected errors of carriage mounted to bearing blocks										
20	Z1 axis straightness	5									
21	Y1 axis straightness	5									
22	thetaX1	40									
23	thetaY1	40									
24	thetaZ1	40									
25											
26											
27	Y3 axis										
28	Y axial sapcing, A_3 (m)	0.25									
29	X width spacing, B_3 (m)	0.25									
30	Bearing block 1 running parallelism errors (microns)		bearing numbers (looking down along X3 axis)								
31	dx3_1 (microns)	5									
32	dz3_1 (microns)	5	3		2						
33	Bearing block 2 running parallelism errors (microns)										
34	dx3_2 (microns)	5	4		1						

Ready

start Topic 4 error budgeting My Documents Microsoft Excel - Erro... Topic 4 Error Budgets...

Error Budget Spreadsheets

- Accuracy and repeatability of a complex machine can be estimated
- Open kinematic chain machines are straightforward to model
- Closed kinematic chains require local calculation of error motion or an equivalent open-chain model
 - E.g., kinematic coupling error motions
 - Bridge-type machines
 - Widely spaced bearings that support a bridge are condensed to a single “very accurate” bearing that supports a cantilever
 - The accuracy of this bearing is based on error motions of a carriage supported by bearings which are spaced the bridge-width apart

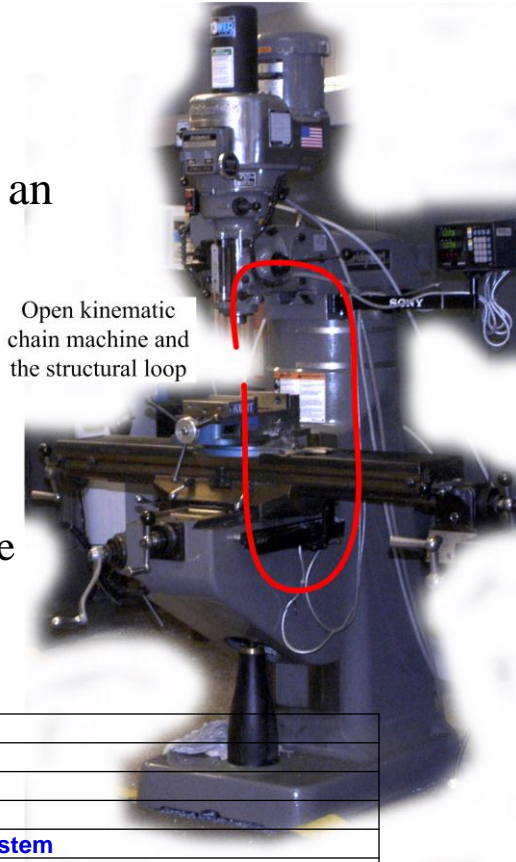

Open kinematic chain machine and the structural loop

ErrorBudgetSpreadsheet.xls
Written by Alex Slocum, John Moore, Whit Rappole October 4, 1999
Last edited by A Slocum Oct 29, 2012 to use direct calculations (no intermediate error gain calcs)
Start with axis at the tool tip, and work back to the reference frame
Enter coordinates: distances in the N-1 coordinate system to get to the origin of the current Nth coordinate system
Remember: HTMs first translate, and THEN rotate. Rotational errors rotate the next (n+1) coordiante system !!!
The HTMs revert to identity matrices for coordinate systems beyond N: do not need to delete entries where CS says "Not Used"
Enter numbers in BOLD, Results in RED, be consistent with units!

Enter Machine Name

Units: Millimeters

Error Budget Spreadsheets

- Tool and work position are each found with respect to a reference coordinate system (CS) using *ErrorBudget.xls*
 - Sketch the structural loop
 - Place coordinate systems (CS) at each major interface (center of stiffness) & each axis of motion
 - Start with CS1 at the base and move to the end
 - Include a CS at the tool tip and on the work piece where the tool is to make contact
 - Enter coordinates
 - Translation in the N-1 CS to get to origin point for the Nth CS
 - Rotation of the Nth CS about its translated origin
 - Enter errors in location of each CS
- It is OK to assume the reference coordinate system is on the work piece where the tool will contact and so there is just the tool system.
- Add worksheets (to the spreadsheet) to estimate axis of motion errors from catalog data and geometry
- Focus on geometric errors

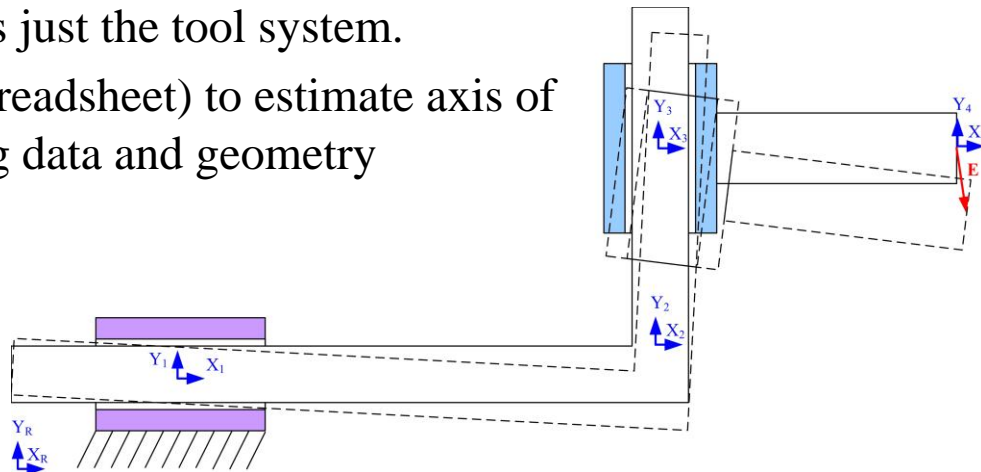

Error Budget Spreadsheets

- Geometric (manufacturing) errors are easily modeled
- Deflections are more easily modeled using a solid model and finite element analysis
- Strategy: Use error apportionment method to assume good design has been done where each of error types is similar, and then just model at this stage the geometric errors.
 - Other error types can then be added to geometric errors

Enter numbers in BOLD **Output is in RED**

Number, N, of coordinate systems (not including reference system) MAXIMUM OF 15			Systematic errors		
			Systematic errors	thermal errors	dynamic errors
3			on	off	on
CS #	Description:	Tool			
3	All errors for this axis on/off			on	
Axes	Distance in N-1 to get to N	Random errors	Systematic errors		
			gemetric	thermal errors	dynamic errors
X		0	1	1	
Y		0			
Z		0			
θX (rad)		0			
θY (rad)		0			
θZ (rad)		0			

Error Budget Spreadsheets

Microsoft Excel - ErrorGainSpreadsheet two axis example.xls

File Edit View Insert Format Tools Data Window Help Adobe PDF

Picture 1

	A	B	C	D	E	F	G	H	I	J	K	L	M
26		Distance in N-1 to get to N	Random errors	Shape errors	thermal errors	dynamic errors	Error descriptions					GX	GY
27	Axes												
28	X	0.5	0.0000	0.0001	0.0000	0.0000	assembly and part geometry errors					1	
29	Y	0	0.0000	0.0001	0.0000	0.0000	assembly and part geometry errors					0	
30	Z	0	0.0000	0.0001	0.0000	0.0000	assembly and part geometry errors					0	
31	θX (rad)	0	0.0000	0.0000	0.0000	0.0000	assembly and part geometry errors					0	
32	θY (rad)	0	0.0000	0.0000	0.0000	0.0000							
33	θZ (rad)	0	0.0000	0.0000	0.0000	0.0000							
34													
35	CS #	Description:	Y axis										
36	3	All errors for this axis on/off	on										
37		Distance in N-1 to get to N	Random errors	Shape errors	thermal errors	dynamic errors							
38	Axes												
39	X	0	0.0001	0.0001	0.0000	0.0000							
40	Y	0.5	0.0001	0.0001	0.0000	0.0000							
41	Z	0	0.0010	0.0001	0.0000	0.0000							
42	θX (rad)	0	0.0004	0.0004	0.0000	0.0000	includes linear guide errors					0	
43	θY (rad)	0	0.0004	0.0004	0.0000	0.0000	includes linear guide errors					-0.0002	
44	θZ (rad)	0	0.0004	0.0004	0.0000	0.0000	includes linear guide errors					-0.0002	0
45													
46	CS #	Description:	Elbow joint										
47	2	All errors for this axis on/off	on										
48		Distance in N-1 to get to N	Random errors	Shape errors	thermal errors	dynamic errors							
49	Axes						Error descriptions					GX	GY
50	X	1	0.0000	0.0001	0.0000	0.0000	assembly and part geometry errors					1	
51	Y	0	0.0000	0.0001	0.0000	0.0000	assembly and part geometry errors					0	
52	Z	0	0.0000	0.0001	0.0000	0.0000	assembly and part geometry errors					0	
53	θX (rad)	0	0.0000	0.0004	0.0000	0.0000	assembly and part geometry errors					0	-2E-4
54	θY (rad)	0	0.0000	0.0004	0.0000	0.0000	assembly and part geometry errors					-0.0002	
55	θZ (rad)	0	0.0000	0.0004	0.0000	0.0000	assembly and part geometry errors					-0.5002	0.49
56													
57	CS #	Description:	X axis										
58	1	All errors for this axis on/off	on										

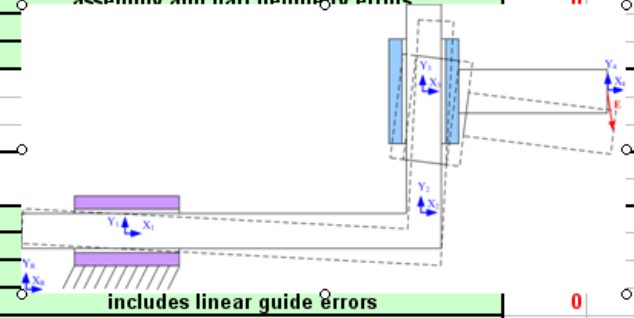

Ready

- Add worksheets to the workbook for computing errors in axes...
- Drag the sketch of the machine around for reference...
- Be VERY careful adding or deleting rows to the main spreadsheet!!!!

Error Budget Spreadsheets

- Remember the purpose of error budgeting is to enable you to try different things...

Nominal coordinate totals	Sum Random Errors in the reference CS		RSS Random Errors in the reference CS		Average SUM & RSS random		Total Systematic Error from Erel HTM to move the endpoint to its correct position in the Ref CS	
X= 2.00E+02	$\delta X =$	3.00E+00	$\delta X =$	1.73E+00	$\delta X =$	2.37E+00	$\delta X =$	-2.00E+00
Y= 0.00E+00	$\delta Y =$	0.00E+00	$\delta Y =$	0.00E+00	$\delta Y =$	0.00E+00	$\delta Y =$	0.00E+00
Z= 0.00E+00	$\delta Z =$	0.00E+00	$\delta Z =$	0.00E+00	$\delta Z =$	0.00E+00	$\delta Z =$	0.00E+00
	ϵX (rad) =	0.00E+00	ϵX (rad) =	0.00E+00	ϵX (rad) =	0.00E+00	ϵX (rad) =	0.00E+00
	ϵY (rad) =	0.00E+00	ϵY (rad) =	0.00E+00	ϵY (rad) =	0.00E+00	ϵY (rad) =	0.00E+00
	ϵZ (rad) =	0.00E+00	ϵZ (rad) =	0.00E+00	ϵZ (rad) =	0.00E+00	ϵZ (rad) =	0.00E+00

Worksheet to estimate error motions of axes supported by linear motion guides

Enters numbers in **BOLD**, Results in **RED**. **NOTE: BE CONSISTENT WITH UNITS**

X1 axis	
X axial sapcing, A (m)	0.25
Z width spacing, B (m)	0.25
Bearing block 1 running parallelism errors (microns)	
dy_1 (microns)	5
dz_1 (microns)	5
Bearing block 2 running parallelism errors (microns)	
dy_2 (microns)	5
dz_2 (microns)	5
Bearing block 3 running parallelism errors (microns)	
dy_3 (microns)	5
dz_3 (microns)	5
Bearing block 4 running parallelism errors (microns)	
dy_4 (microns)	5
dz_4 (microns)	5
Expected errors of carriage mounted to bearing blocks	
Y1 axis straightness (m)	0.000005
Z1 axis straightness (m)	0.000005
thetaX1 (m)	0.00004
thetaY1 (m)	0.00004
thetaZ1 (m)	0.00004

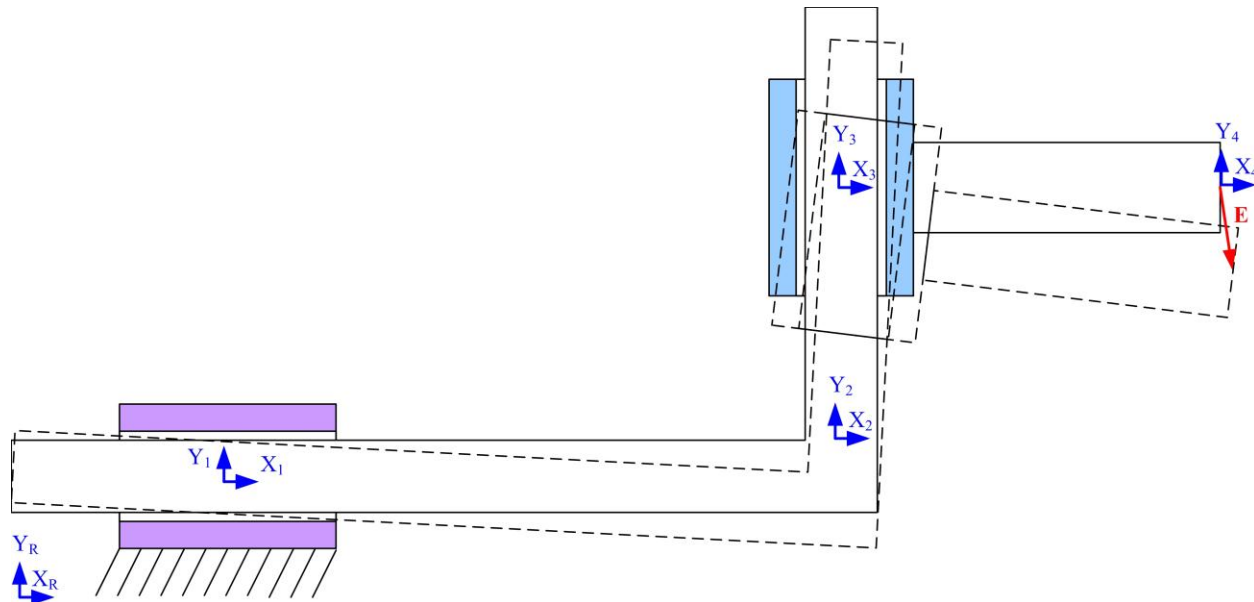

Fun Example: Disney Camera Stand

- Machine to scan large hand painted images for tiling
 - Used for Feature Animations from Hunchback on (until digital took over)
- Worked with Convolve Inc (controls) and Moore Tool (design and mfg)
 - Concept to delivery in 6 months
 - 5 micron accuracy machine realized
 - Error Budget spot on!

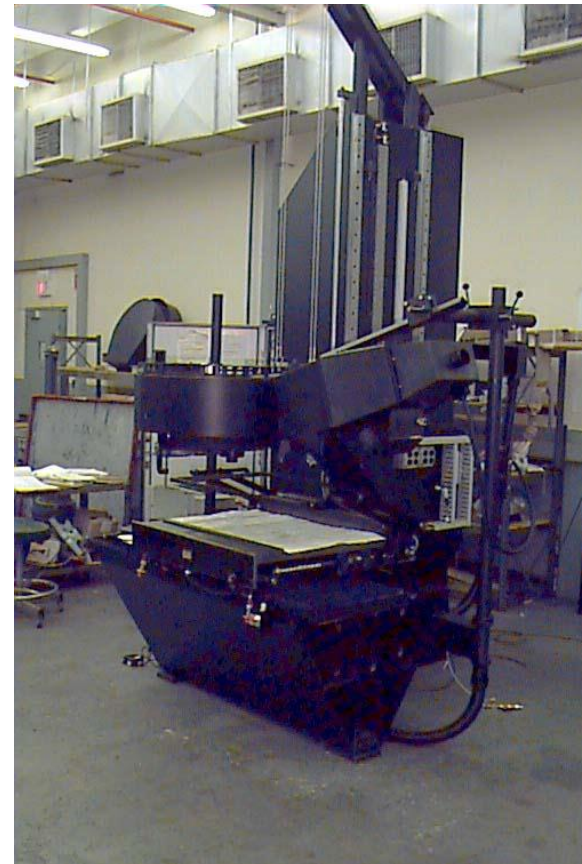
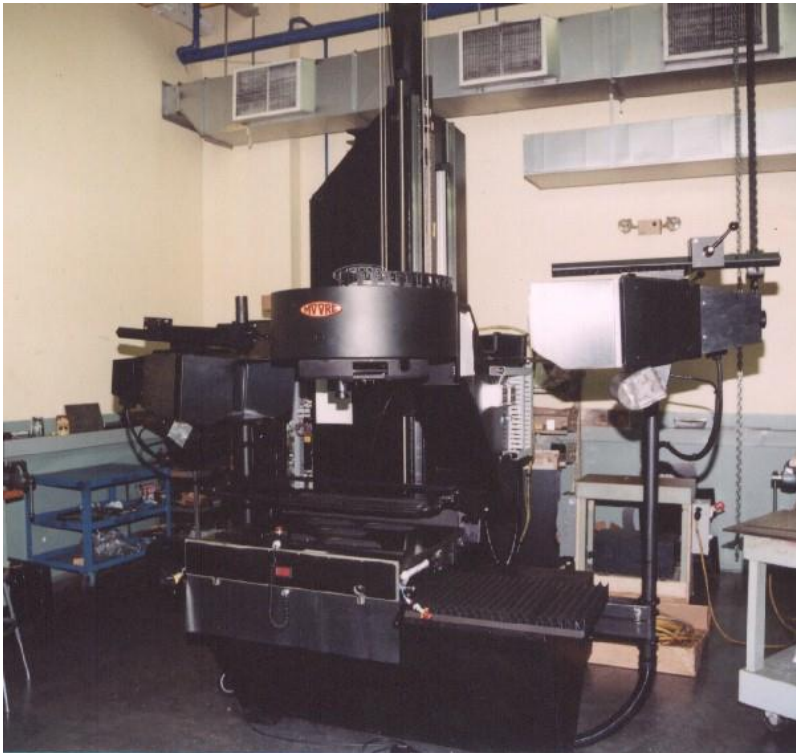

Closed Structural Loop Example

- If you have a closed kinematic chain, assume a kinematic constraint
- Example from kinematic couplings
 - Slocum, A. H. "Design of Three-Groove Kinematic Couplings," Jou. Int. Soc. of Precision Engineering and Nanotechnology, Vol. 14, No. 2, April 1992, pp 67-76.
- In general, the strategy is to identify a plane by three points and then compute the change in plane position and orientation after errors are applied

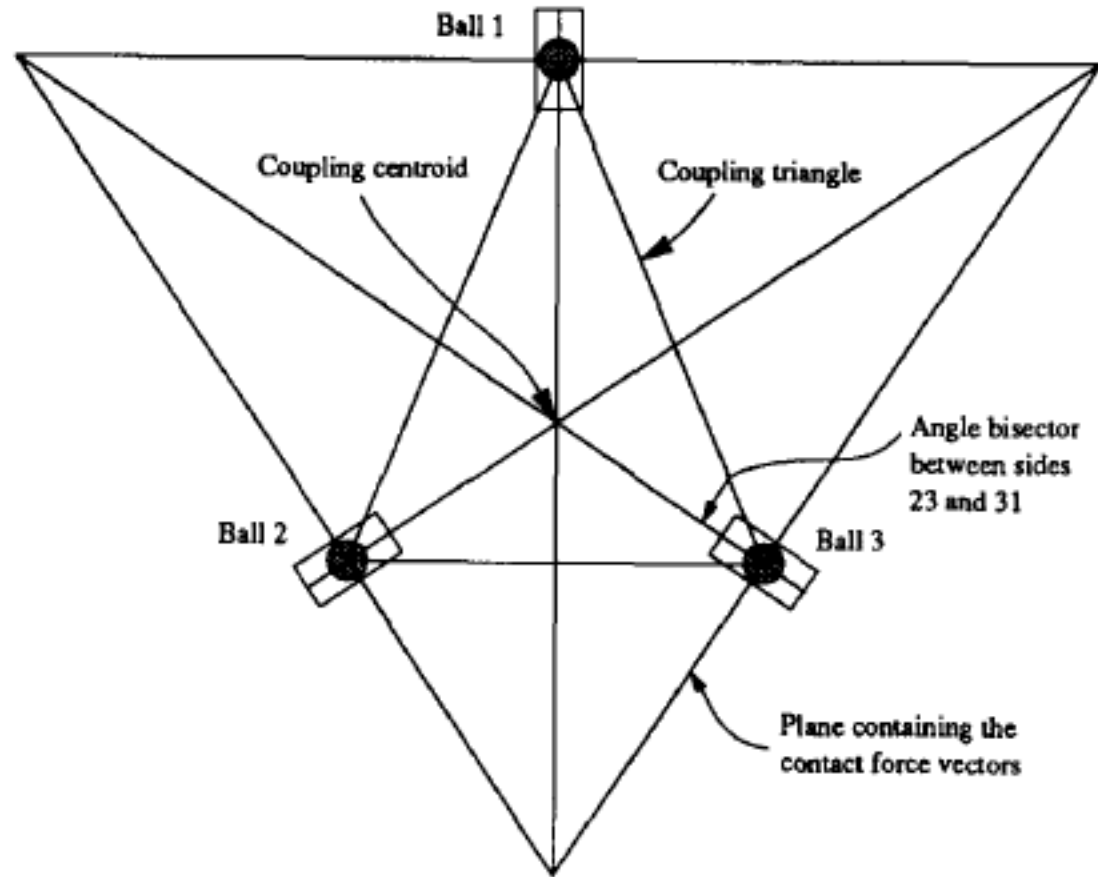

Figure 2 For good stability in a three-groove kinematic coupling, the normals to the planes containing the contact force vectors should bisect the angles between the balls

Closed Structural Loop: Check Stability

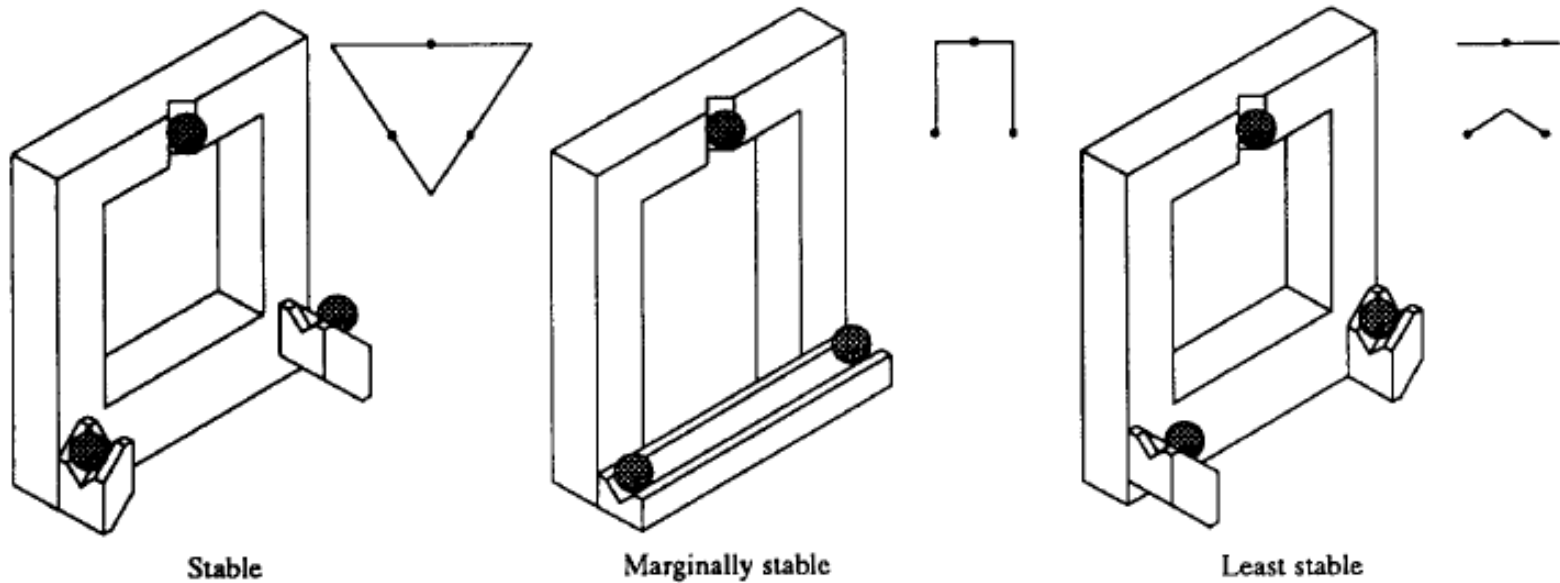

Figure 4 Different configurations for a kinematic coupling that illustrate how the intersections of the planes containing the contact force vectors can be used to make an assessment of the coupling's stability

Define Direction Cosines

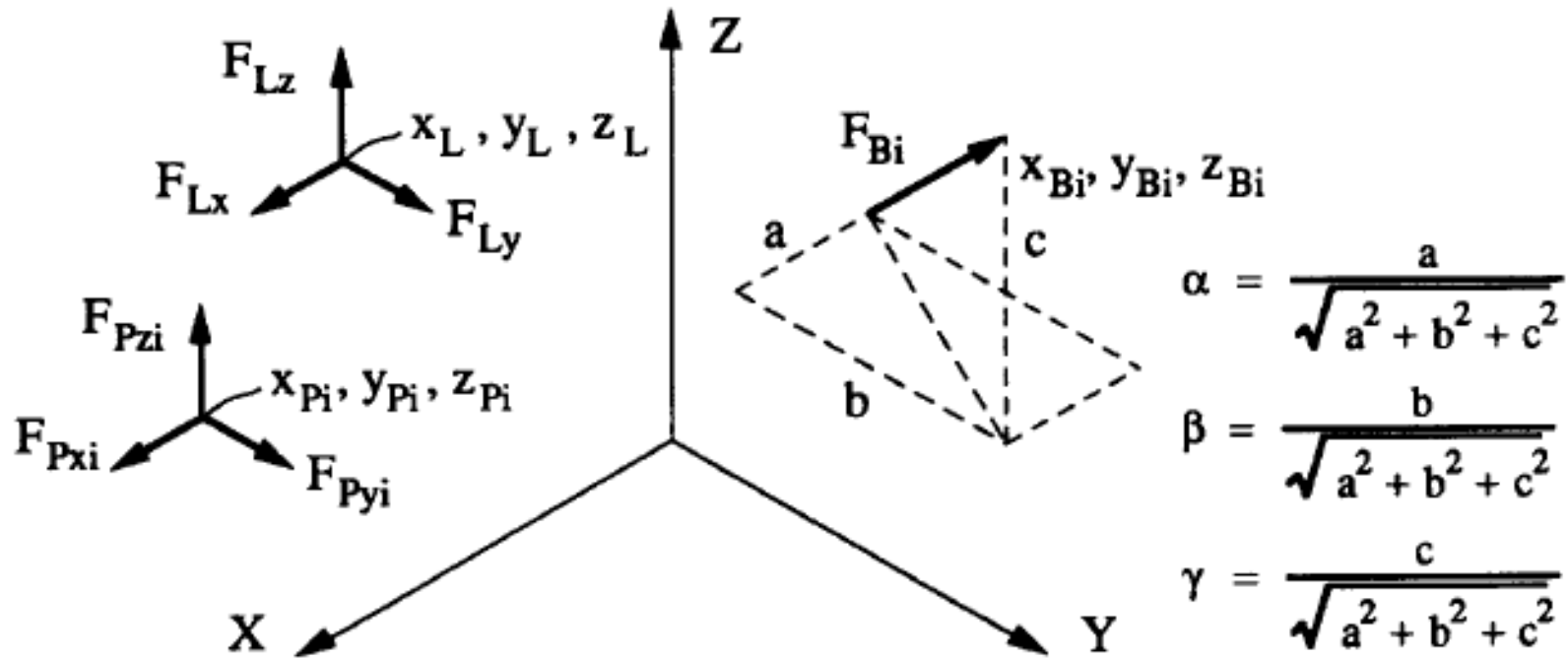

Figure 5 Information required to define a three-groove kinematic coupling

Deflections

- Determining the forces and moments at the contact points enables so deflections can be determined based on Hertz contact stiffness

Force and moment equilibrium

The force and moment balance equations for the system are

$$\sum_{i=1}^6 F_{Bi} \alpha_{Bi} + \sum_{i=1}^3 F_{Pxi} + F_{Lx} = 0 \quad (1)$$

$$\sum_{i=1}^6 F_{Bi} \beta_{Bi} + \sum_{i=1}^3 F_{Pyi} + F_{Ly} = 0 \quad (2)$$

$$\sum_{i=1}^6 F_{Bi} \gamma_{Bi} + \sum_{i=1}^3 F_{Pzi} + F_{Lz} = 0 \quad (3)$$

$$\begin{aligned} & \sum_{i=1}^6 F_{Bi} (-\beta_{Bi} z_{Bi} + \gamma_{Bi} y_{Bi}) \\ & + \sum_{i=1}^3 (-F_{Pyi} z_{Pi} + F_{Pzi} y_{Pi}) - F_{Ly} z_L + F_{Lz} y_L = 0 \end{aligned} \quad (4)$$

$$\begin{aligned} & \sum_{i=1}^6 F_{Bi} (\alpha_{Bi} z_{Bi} - \gamma_{Bi} x_{Bi}) \\ & + \sum_{i=1}^3 (F_{Pxi} z_{Pi} - F_{Pzi} x_{Pi}) + F_{Lx} z_L - F_{Lz} x_L = 0 \end{aligned} \quad (5)$$

$$\begin{aligned} & \sum_{i=1}^6 F_{Bi} (-\alpha_{Bi} y_{Bi} + \beta_{Bi} x_{Bi}) \\ & + \sum_{i=1}^3 (-F_{Pxi} y_{Pi} + F_{Pyi} x_{Pi}) - F_{Lx} y_L + F_{Ly} x_L = 0 \end{aligned} \quad (6)$$

Error Motion Assumptions

- The strategy is to identify a plane by three points and then compute the change in plane position and orientation after errors are applied

Kinematics of the coupling's error motions

The contact between the ball and the groove actually results in an elastic indentation of the region. Combined with a finite coefficient of friction, it is reasonable to assume that there is no relative motion between the ball and the groove at the contact interface. If one makes this assumption and then calculates the new position of the balls' centers using the contact displacements and contact forces' direction cosines, then one finds that there is not a unique homogeneous transformation matrix that relates the old and new ball positions. These factors make the calculation of a kinematic coupling's error motions a nondeterministic problem.

Error Motion Assumptions

Fortunately, if the distances between the balls, determined using their new coordinates, do not change greatly, then reasonable estimates can be made of the coupling's error motions. Using the design theory presented herein, a spreadsheet can be used to show that the change in distance between the balls is typically five to ten times less than the deflection at the contact points. Furthermore, the ratio of the change in the distance between the balls to the distance between the balls is typically an order of magnitude less than the ratio of the deflection of the ball to the ball diameter (see the calculations in Appendix A).

Error Motion Kinematics

- The rotations of the coupling about the X- and Y-axes are conveniently determined for the case of a coupling whose grooves lie in the X-Y plane (other orientations confuse the angle definition in the spreadsheet analysis). To determine the rotations, the altitudes of the coupling triangle and its sides' orientation angles must be determined as shown in *Figure 6*. With these geometric calculations, the rotations about the X- and Y-axes can be determined:

$$\varepsilon_x = \frac{\delta_{z1}}{L_{1,23}} \cos \theta_{23} + \frac{\delta_{z2}}{L_{2,31}} \cos \theta_{31} + \frac{\delta_{z3}}{L_{3,12}} \cos \theta_{12} \quad (17)$$

$$\varepsilon_y = \frac{\delta_{z1}}{L_{1,23}} \sin \theta_{23} + \frac{\delta_{z2}}{L_{2,31}} \sin \theta_{31} + \frac{\delta_{z3}}{L_{3,12}} \sin \theta_{12} \quad (18)$$

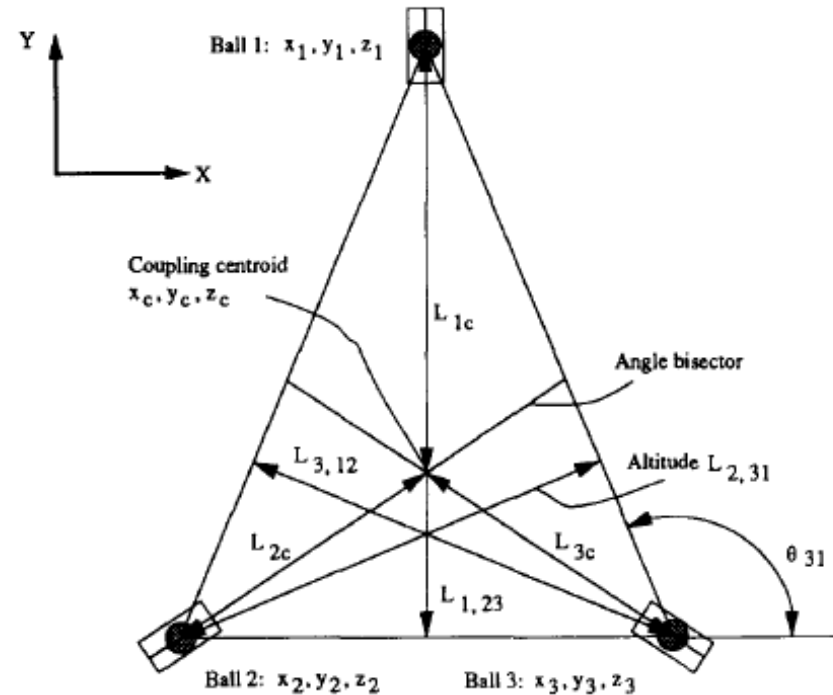

Figure 6 Geometry of a planar kinematic coupling

Error Motion Assumptions

- The product of the deflection of the balls with the contact forces' direction cosines are used to calculate the ball's deflections. The displacements of the coupling triangle's centroid, $\delta_{\xi c}$ ($\xi = x, y, z$), are assumed to be the equal to the weighted average (by the distance between the balls and the coupling centroid) of the ball's deflections:

$$\delta_{\xi c} = \left(\frac{\delta_{1\xi}}{L_{1c}} + \frac{\delta_{2\xi}}{L_{2c}} + \frac{\delta_{3\xi}}{L_{3c}} \right) \frac{L_{1c} + L_{2c} + L_{3c}}{3} \quad (16)$$

Error Motion Kinematics

calculated for each ball. For example, the rotation about a Z-direction through the coupling centroid caused by ball 1 is

$$\varepsilon_{z1} = \frac{\sqrt{(\alpha_{B1}\delta_1 + \alpha_{B2}\delta_2)^2 + (\beta_{B1}\delta_1 + \beta_{B2}\delta_2)^2}}{\sqrt{(x_1 - x_c)^2 + (y_1 - y_c)^2}} \times \text{SIGN}(\alpha_{B1}\delta_1 + \alpha_{B2}\delta_2) \quad (19)$$

The rotation error about the Z-axis of the coupling is assumed to be

$$\varepsilon_z = \frac{\varepsilon_{z1} + \varepsilon_{z2} + \varepsilon_{z3}}{3} \quad (20)$$

—

Error Motion Kinematics

The errors can then be assembled into a homogeneous transformation matrix for the coupling that allows for the determination of the translational errors δ_x , δ_y , and δ_z at any point x , y , or z in space around the coupling:

$$\begin{bmatrix} \delta_x \\ \delta_y \\ \delta_z \\ 1 \end{bmatrix} = \begin{bmatrix} 1 & -\varepsilon_z & \varepsilon_y & \delta_x \\ \varepsilon_z & 1 & -\varepsilon_x & \delta_y \\ -\varepsilon_y & \varepsilon_x & 1 & \delta_z \\ 0 & 0 & 0 & 1 \end{bmatrix} \begin{bmatrix} x - x_c \\ y - y_c \\ z - z_c \\ 1 \end{bmatrix} - \begin{bmatrix} x - x_c \\ y - y_c \\ z - z_c \\ 0 \end{bmatrix} \quad (21)$$

In the homogeneous transformation matrix it has been assumed that the rotations are small, so small angle trigonometric approximations are valid. Also, the error motions had been calculated about the coupling triangle's centroid, which may not be coincident with the coordinate system's origin; hence, the centroid coordinates are subtracted from the location at which the errors are to be determined.

FUNdaMENTALS of Design

Principles in Support of Error Budgeting

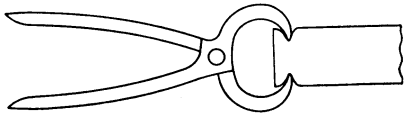

Topic 3

*FUN*daMENTAL Principles

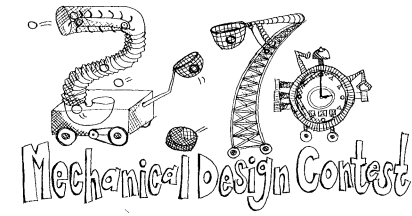

Topics

- Occam's Razor
- Newton's Laws
- Conservation of Energy
- Saint-Venant's Principle
- Golden Rectangle
- Abbe's Principle
- Maxwell & Reciprocity
- Self-Principles
- Stability
- Symmetry
- Parallel Axis Theorem
- Accuracy, Repeatability, Resolution
- Sensitive Directions & Reference Features
- Structural Loops
- Preload
- Centers of Action
- Exact Constraint Design
- Elastically Averaged Design
- Stick Figures

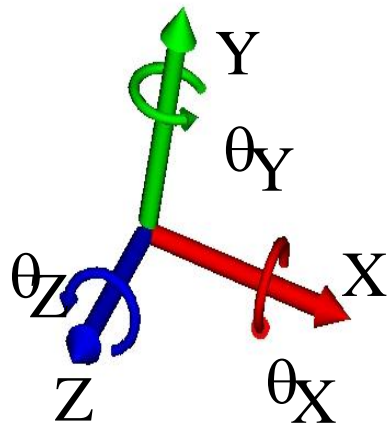
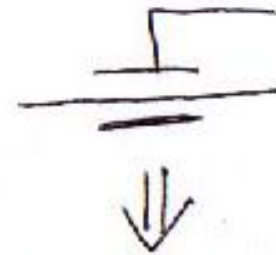
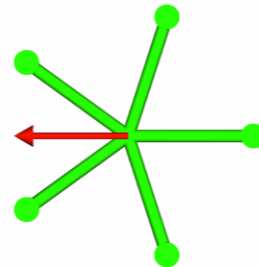
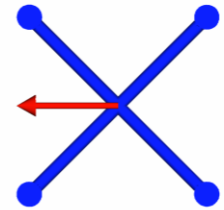
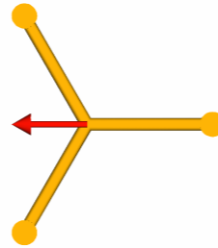
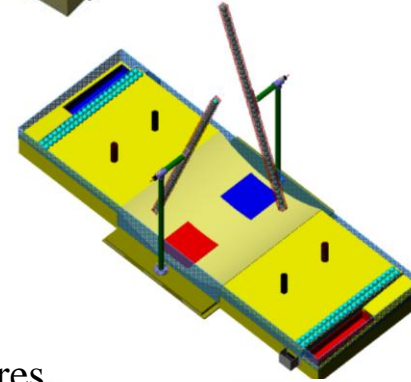
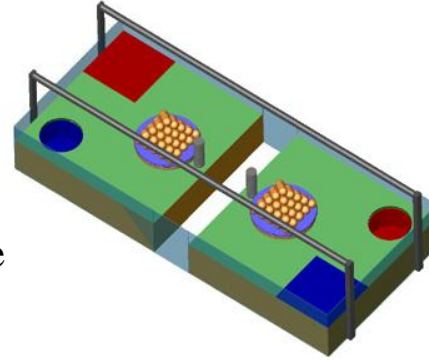

Occam's Razor

- William of Occam (Ockham) (1284-1347) was an English philosopher and theologian
 - Ockham stressed the Aristotelian principle that *entities must not be multiplied beyond what is necessary* (see Maudslay's maxims on page 1-4)



- “The medieval rule of parsimony, or principle of economy, frequently used by Ockham came to be known as **Ockham's razor**. The rule, which said that *plurality should not be assumed without necessity* (or, in modern English, *keep it simple, stupid*), was used to eliminate many pseudo-explanatory entities” (<http://wotug.ukc.ac.uk/parallel/www/occam/occam-bio.html>)
- **A problem should be stated in its most basic and simplest terms**
- **The simplest theory that fits the facts of a problem is the one that should be selected**
- **Limit Analysis can be used to check ideas**

- Use fundamental principles as catalysts to help you
 - Keep It Super Simple (KISS)
 - Make It Super Simple (MISS)
 - “Silicon is cheaper than cast iron” (Don Blomquist)

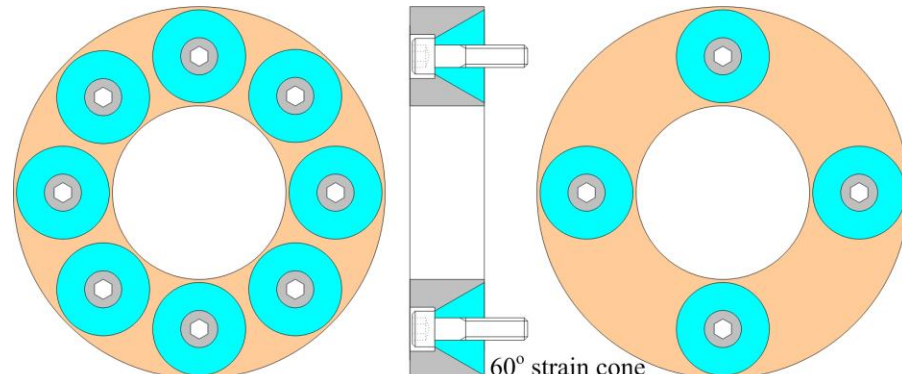
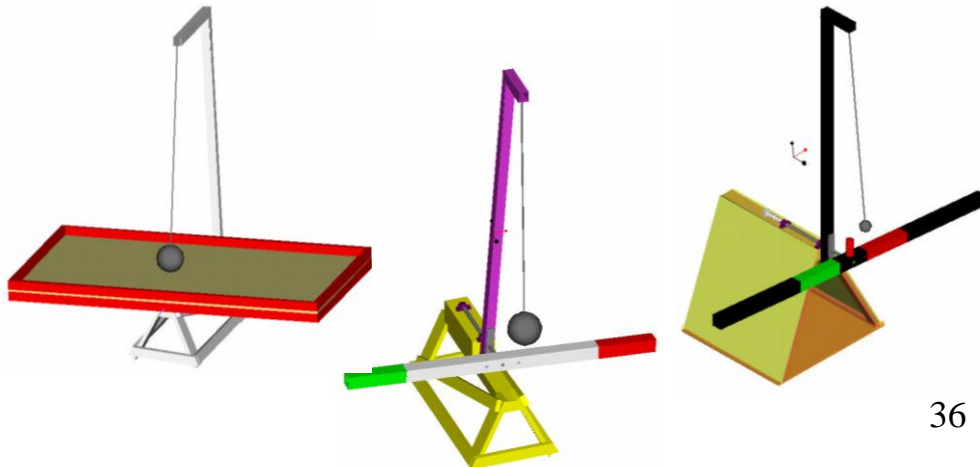
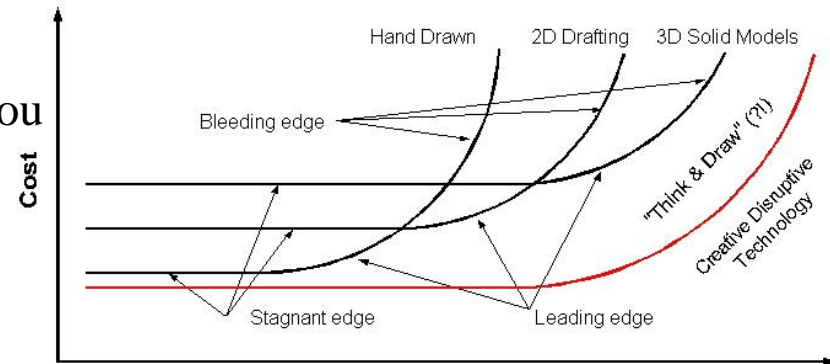

Saint-Venant's Principle

- Saint-Venant did research in the theory of elasticity, and often he relied on the assumption that local effects of loading do not affect global strains
 - e.g., bending strains at the root of a cantilever are not influenced by the local deformations of a point load applied to the end of a cantilever
- The engineering application of his general observations are profound for the development of conceptual ideas and initial layouts of designs:
 - To NOT be affected by local deformations of a force, be several characteristic dimensions away
 - How many seats away from the sweaty dude do you want to be?
 - Several can be interpreted as 3-5
 - To have control of an object, apply constraints over several characteristic dimensions
 - These are just initial layout guidelines, and designs must be optimized using closed-form or finite element analysis

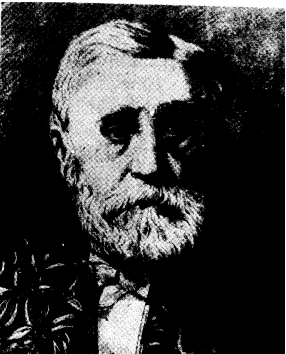

Barré de Saint-Venant

1797-1886

One of the most powerful principles in your drawer of **FUNdaMENTALS**

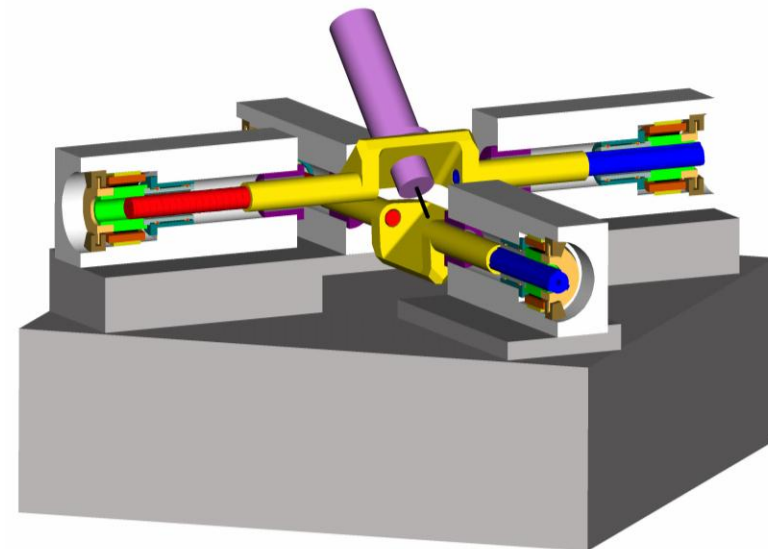
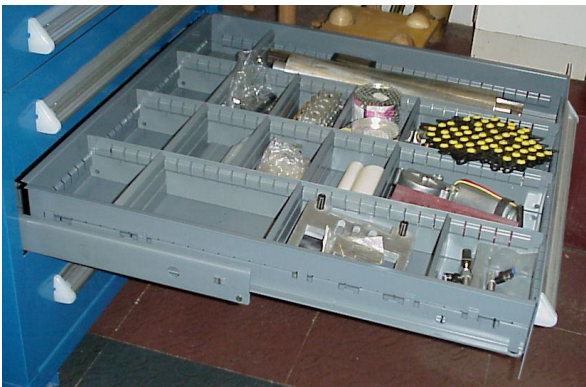

Saint-Venant's Principle: *Structures*

- To NOT feel something's effects, be several characteristic dimensions away!
 - If a plate is 5 mm thick and a bolt passes through it, you should be 3 plate thicknesses away from the bolt force to not cause any warping of the plate!
 - Many bearing systems fail because bolts are too close to the bearings
 - Beware the strain cone under a bolt that deforms due to bolt pressure!
 - Strain cones should overlap in the vicinity bearings to prevent wavy deformations
 - BUT check the design's functional requirements, and only use as many bolts as are needed!
- To DOMINATE and CONTROL something, control several characteristic dimensions
 - If a column is to be cantilevered, the anchor region should be 3 times the column base area
 - Too compliant machines (lawn furniture syndrome) often have poor proportions
 - Diagonal braces can be most effective at stiffening a structure

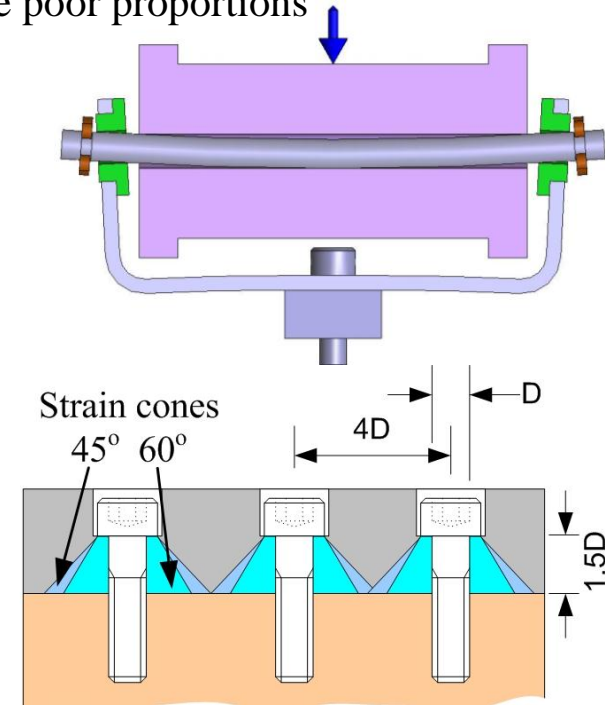
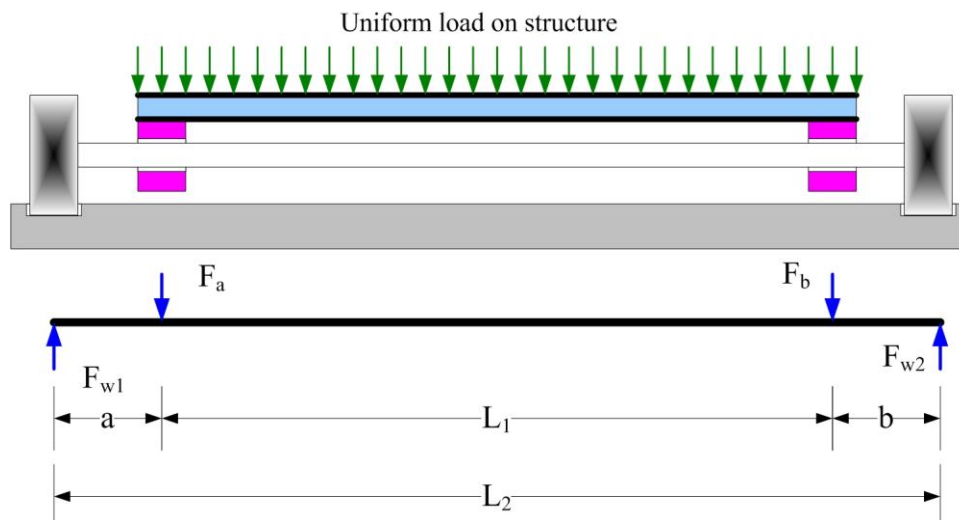

Saint-Venant's Principle: *Bearings*

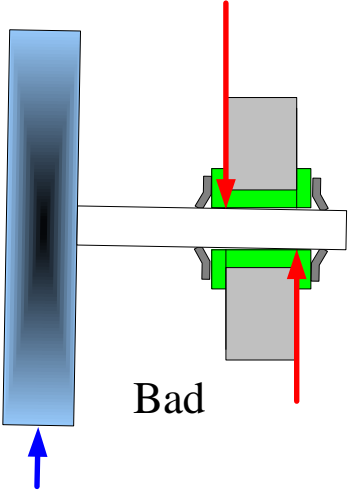
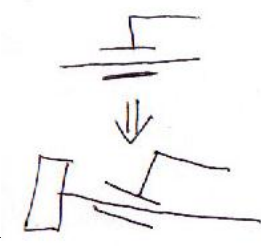

Bad

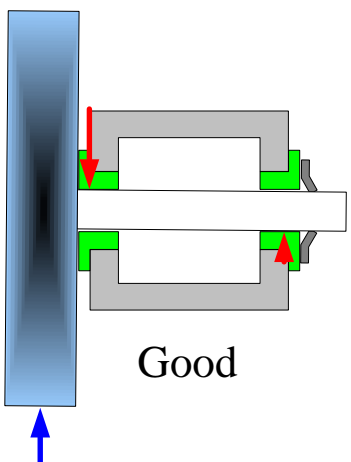

Good

- Saint-Venant: *Linear Bearings*:
 - Make friction (μ) low and $L/D > 1$, 1.6:1 very good, 3:1 awesome
 - Every year some students try $L/D < 1$ and their machines jam!
 - Wide drawers guided at the outside edges can jamb
 - Wide drawers guided by a central runner do not!
 - If $L/D < 1$, actuate both sides of the slide!
- Saint-Venant: *Rotary Bearings*:
 - $L/D > 3$ if the bearings are to act to constrain the shaft like a cantilever
 - IF $L/D < 3$, BE careful that slope from shaft bending does edge-load the bearings and cause premature failure
 - For sliding contact bearings, angular deformations can cause a shaft to make edge contact at both ends of a bearing
 - This can cause the bearing to twist, seize, and fail
 - Some shaft-to bearing bore clearance must always exist

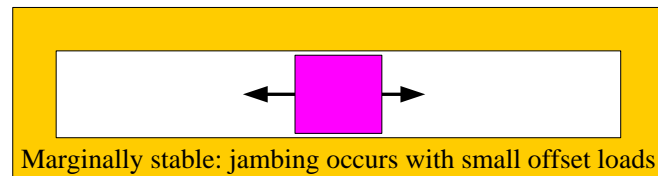
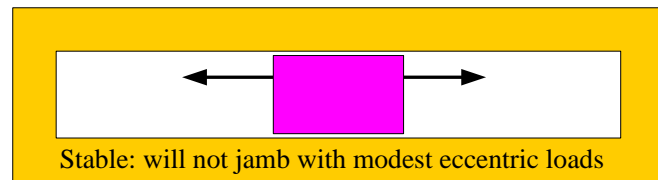
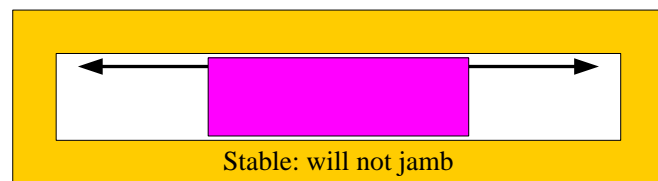
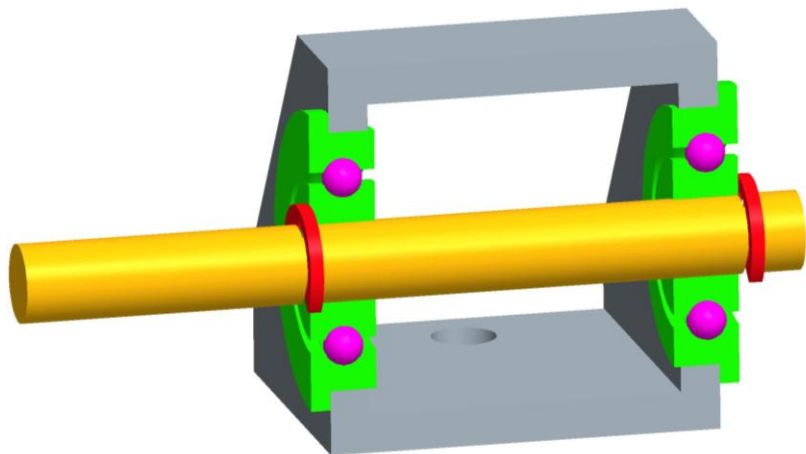

The Golden Rectangle

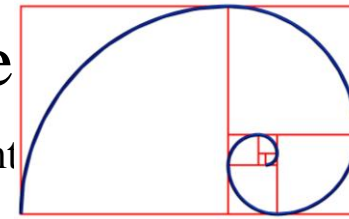

- The proportions of the *Golden Rectangle* are a natural starting point for preliminary sizing of structures and elements

- Golden Rectangle*: A rectangle where when a square is cut from the rectangle, the remaining rectangle has the same proportions as the original rectangle: $a/b = 1/(a-b)$

- See and study *Donald in Mathmagic Land!*

- Try a *Golden Solid*: 1: 1.618: 2.618, & the diagonal has length $2a = 3.236$

100

- Example: Bearings:

- The greater the ratio of the longitudinal to latitudinal (length to width) spacing: 162

- The smoother the motion will be and the less the chance of walking (yaw error)

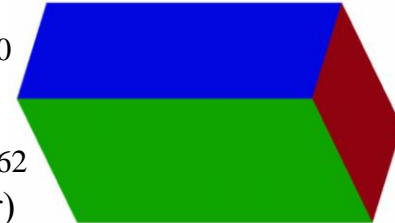

- First try to design the system so the ratio of the longitudinal to latitudinal spacing of bearing elements is about 2:1

- For the space conscious, the bearing elements can lie on the perimeter of a golden rectangle (ratio about 1.618:1)

- The minimum length to width ratio should be 1:1

- To minimize yaw error

- Depends on friction too



Pythagoras of Samos
569 BC-475 BC

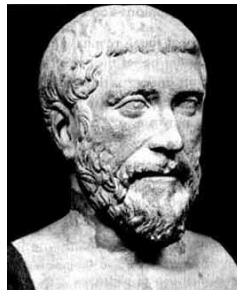

http://www-gap.dcs.st-and.ac.uk/~history/Mathematicians/Pythagoras.html

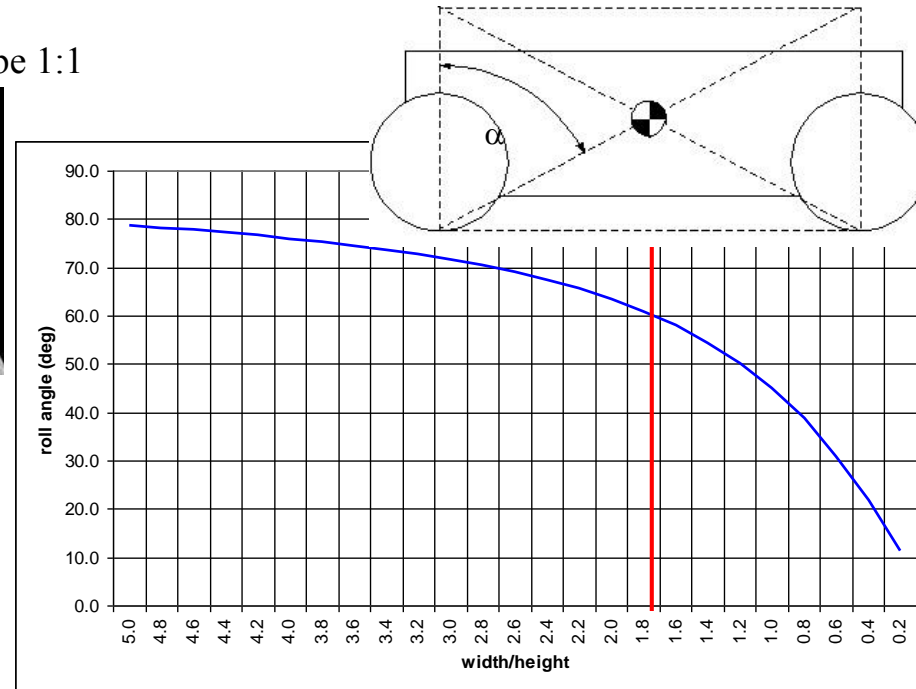
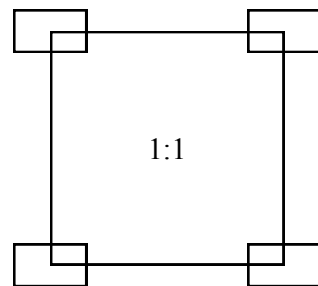
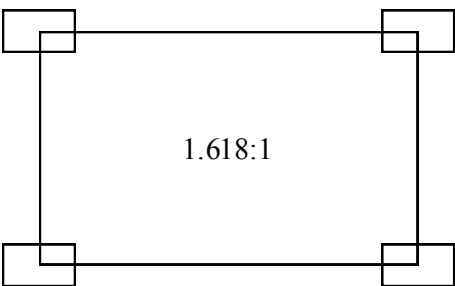

Abbe's Principle

- In the late 1800s, Dr. Ernst Abbe (1840-1905) and Dr. Carl Zeiss (1816-1888) worked together to create one of the world's foremost precision optics companies: Carl Zeiss, GmbH (<http://www.zeiss.com/us/about/history.shtml>)
- The Abbe Principle (*Abbe errors*) resulted from observations about measurement errors in the manufacture of microscopes:
 - *If errors in parallax are to be avoided, the measuring system must be placed coaxially with the axis along which the displacement is to be measured on the workpiece*
 - Strictly speaking, the term *Abbe error* only applies to measurement errors
- When an angular error is amplified by a distance, e.g., to create an error in a machine's position, the strict definition of the error is a *sine* or *cosine* error



From www.zeiss.com

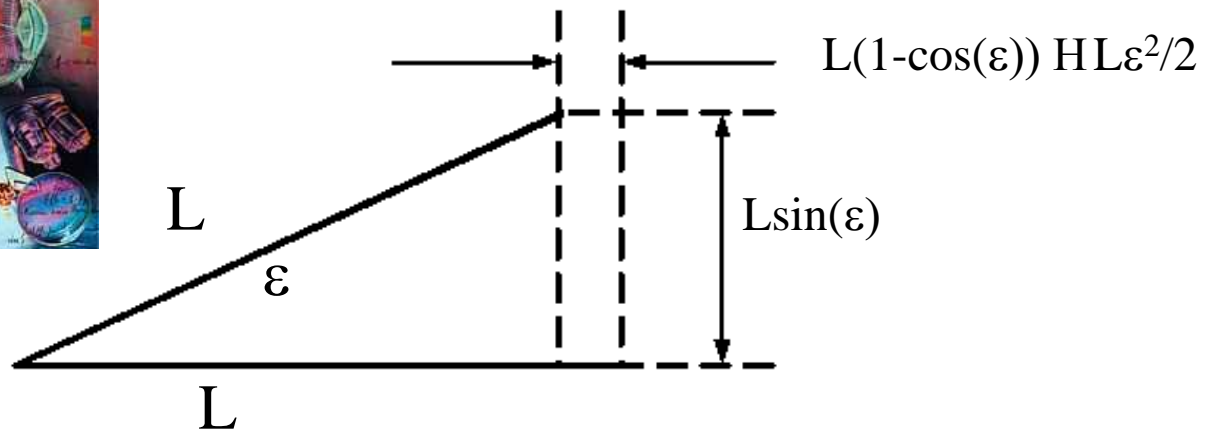

Abbe's Principle: *Locating Components*

- Geometric: Angular errors are amplified by the distance from the source
 - Measure near the source, and move the bearings and actuator near the work!
- Thermal: Temperatures are harder to measure further from the source
 - Measure near the source!

On Brown & Sharpe's vernier caliper: "It was the first practical tool for exact measurements which could be sold in any country at a price within the reach of the ordinary machinist, and its importance in the attainment of accuracy for fine work can hardly be overestimated"

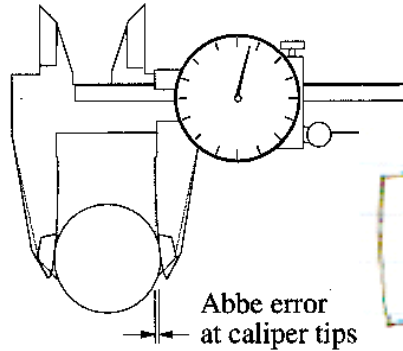
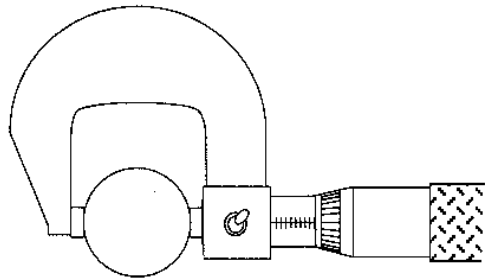

- Thinking of Abbe errors, and the system FRs is a powerful catalyst to help develop DPs, where location of motion axes is depicted schematically
 - Example: Stick figures with arrows indicating motions are a powerful simple means of depicting *strategy* or *concepts*

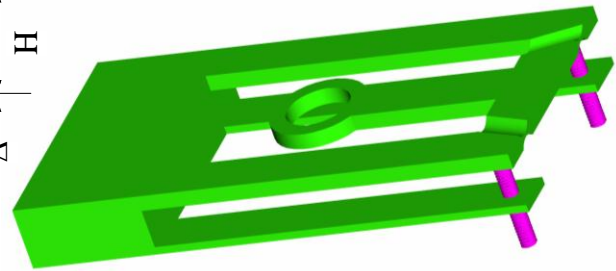
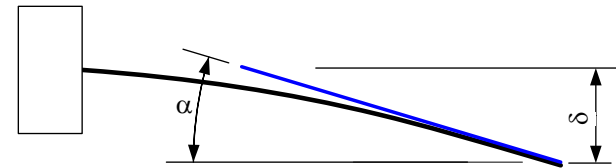
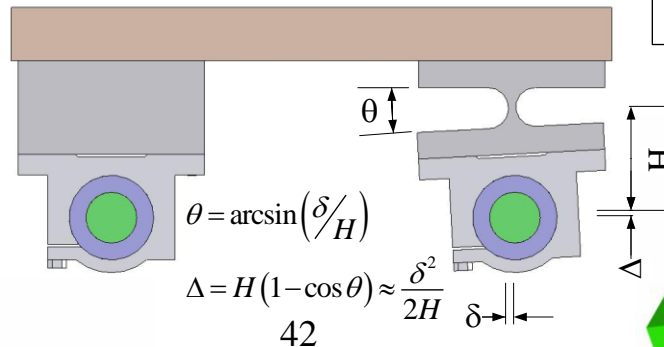
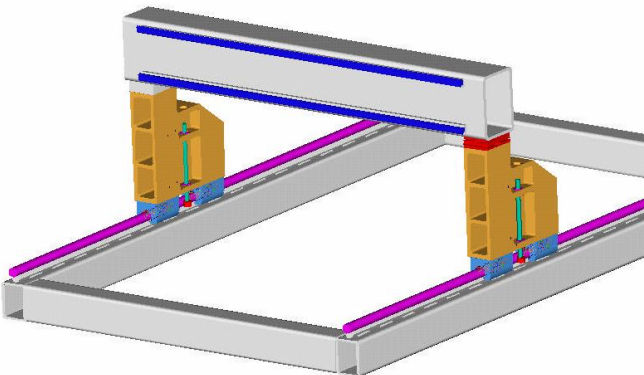
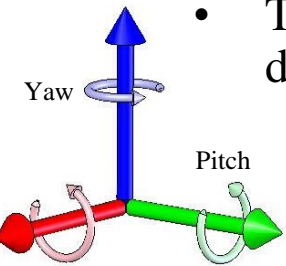

Abbe's Principle: *Cascading Errors*

- A small angular deflection in one part of a machine quickly grows as subsequent layers of machine are stacked upon it...
 - A component that tips on top of a component that tips...
 - *If You Give a Mouse a Cookie...* (great kid's book for adults!)
- Error budgeting keeps tracks of errors in cascaded components
 - Designs must consider not only linear deflections, but angular deflections and their

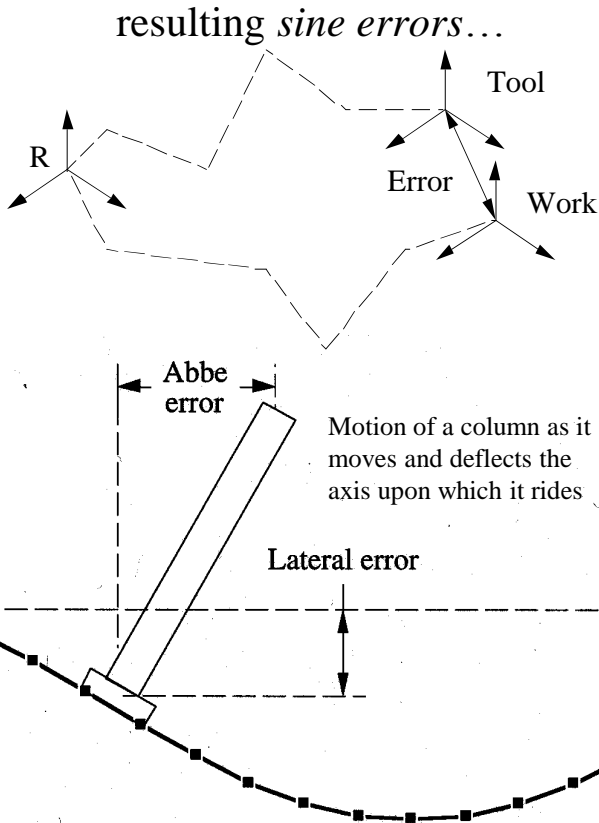

$$d_v = \frac{FL^3}{3EI}$$

$$\theta = \frac{FL^2}{2EI} = \frac{3d_v}{2L}$$

$$d_h = h\theta = \frac{3hd_v}{2L}$$

$$\Rightarrow \text{"transmission ratio"} = \frac{d_h}{d_v} = \frac{3h}{2L}$$

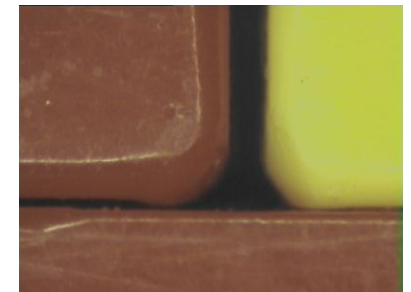
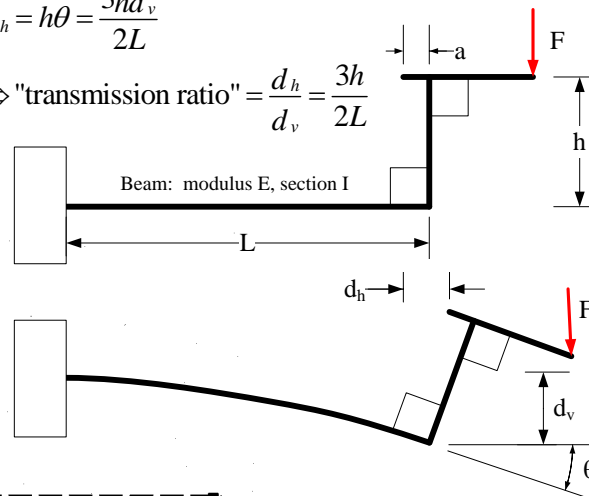

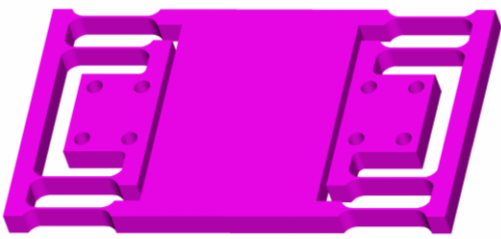

Maxwell & Reciprocity



$$\frac{1}{\text{problem}} = \text{opportunity!} \quad \frac{1}{\text{Ow!}} = \text{Ahhhhh!}$$

- Maxwell's theory of *Reciprocity*
 - Let A and B be any two points of an elastic system. Let the displacement of B in any direction U due to a force P acting in any direction V at A be u ; and the displacement of A in the direction V due to a force Q acting in the direction U at B be v . Then $Pv = Qu$ (from Roark and Young Formulas for Stress and Strain)
- The principle of *reciprocity* can be extended in philosophical terms to have a profound effect on measurement and development of concepts
 - Reversal
 - Critical Thinking

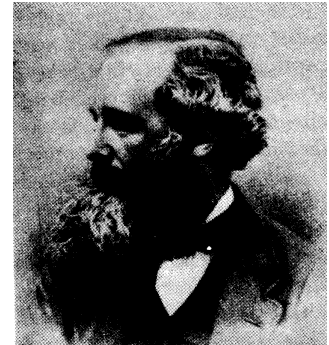

James Clerk Maxwell 1831-1879

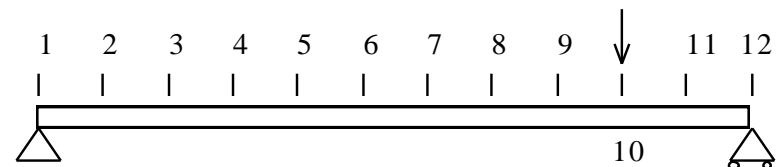
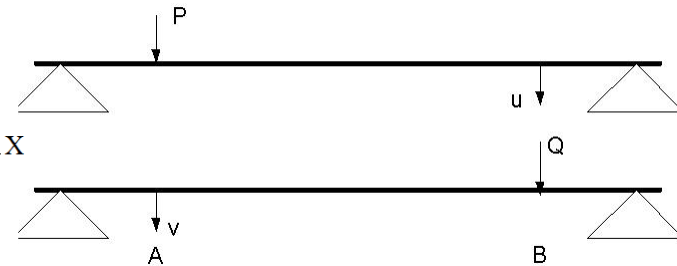
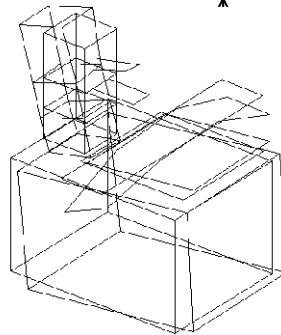
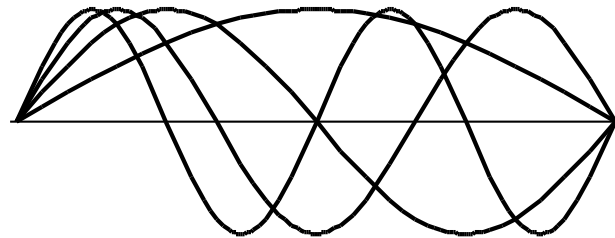
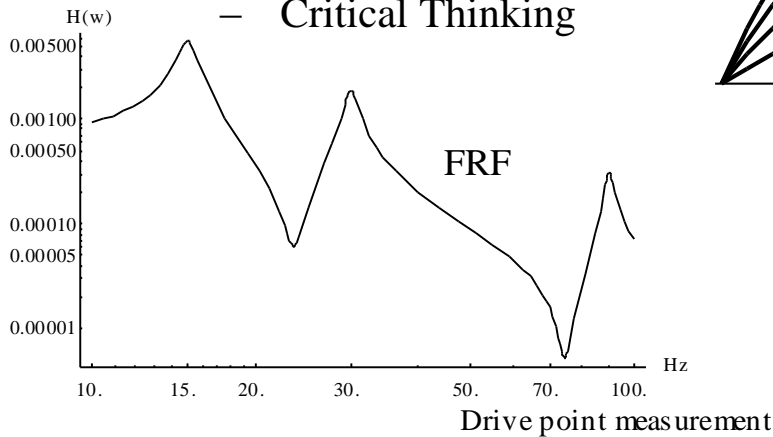

Maxwell & Reciprocity: *Reversal*

- *Reversal* is a method used to remove repeatable measuring instrument errors
 - A principal method for continual advances in the accuracy of mechanical components
- There are many applications for measurement and manufacturing
 - Two bearings rails ground side-by-side can be installed end-to-end
 - A carriage whose bearings are spaced one rail segment apart will not pitch or roll
 - Scraping three plates flat

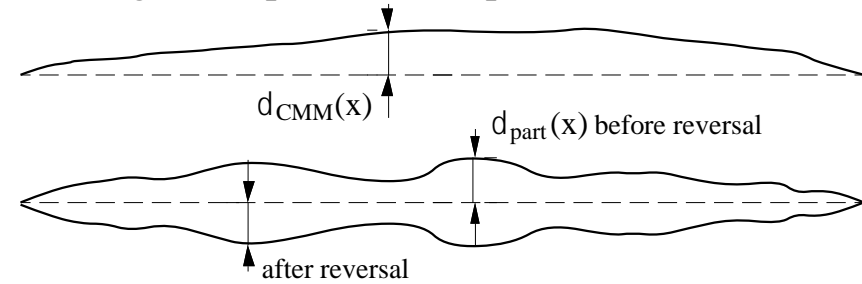

$$Z_{\text{probe before reversal}}(x) = \delta_{CMM}(x) - \delta_{\text{part}}(x)$$

$$Z_{\text{probe after reversal}}(x) = \delta_{CMM}(x) + \delta_{\text{part}}(x)$$

$$\delta_{\text{part}}(x) = \frac{-Z_{\text{probe before reversal}}(x) + Z_{\text{probe after reversal}}(x)}{2}$$

Coordinate Measuring Machine (CMM) repeatability

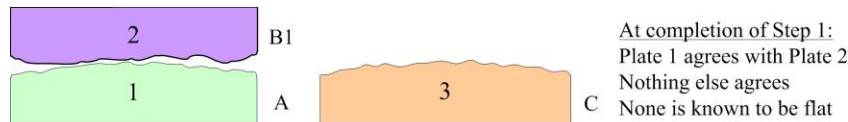
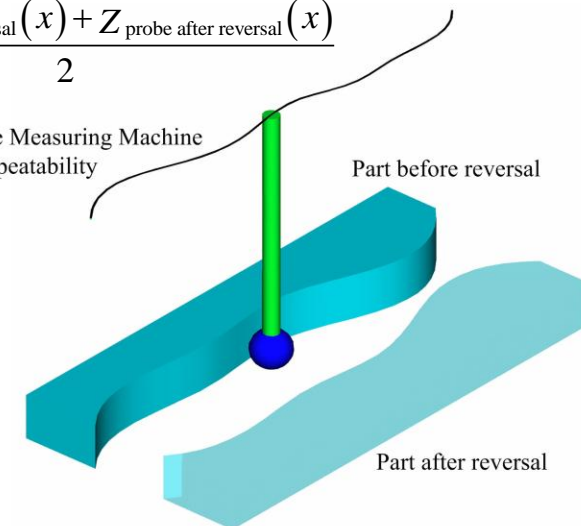

At completion of Step 1:
Plate 1 agrees with Plate 2
Nothing else agrees
None is known to be flat

Step 1: Neither plate is the control plate. This step is completed when there is general agreement between plates 1 and 2

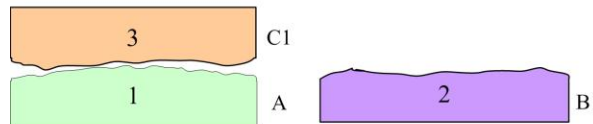

At completion of Step 2:
Plate 2 agrees with Plate 1
Plate 3 agrees with Plate 1
Plate 2 does not agree with Plate 3
None is known to be flat

Step 2: Plate 1 is the control plate. This step is completed when plates 1 & 2 have both picked up Plate 1's error

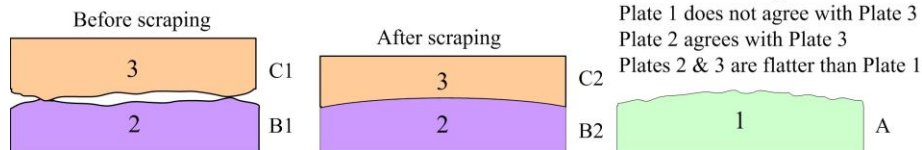

At completion of Step 3:
Plate 1 does not agree with Plate 2
Plate 1 does not agree with Plate 3
Plate 2 agrees with Plate 3
Plates 2 & 3 are flatter than Plate 1

Step 3: Neither plate is the control plate. By scraping some of Plate 1's error off of Plate 2, and some off of Plate 3, Plates 2 & 3 get flatter

After T. Busch, *Fundamentals of Dimensional Metrology*,
Delmar Publishers, Albany, NY, 1964

Stability

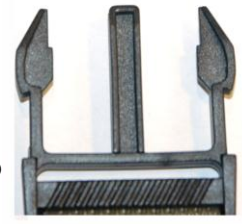

- All systems are either *stable*, *neutral*, or *unstable*

- Saint-Venant's principle was applied to bearing design to reduce the chance of sliding instability (e.g., a drawer jamming)

- A snap-fit uses an applied force to move from a stable, to a neutrally stable, to an unstable to a final new stable position

- Wheels allow a system to roll along a flat surface

- As the load on a tall column increases, infinitesimal lateral deflections are acted on by the axial force to become bending moments, which increase the deflections....

- Reciprocity says this detrimental effect can be useful: fire sprinklers are activated by a column that buckles when it becomes soft...

- *Back-to-back* mounted bearings are intolerant of misalignment, but use axial thermal growth to cancel radial thermal growth for constant preload and thermal stability at high speeds

- *Face-to-face* mounted bearings are tolerant of misalignment, but axial thermal growth adds to radial thermal growth and causes the bearings to become overloaded and seize at high speeds

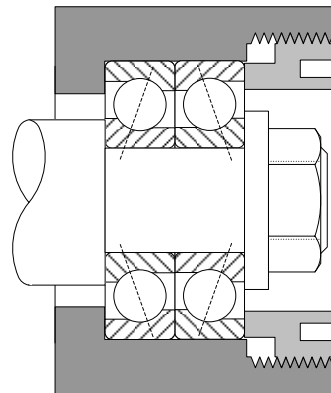
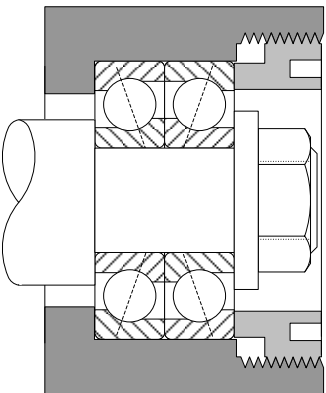
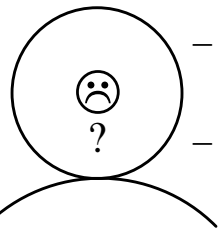
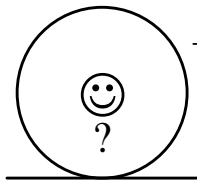
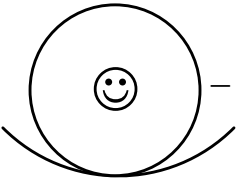

face-to-face mounting *can* accommodate shaft misalignment but *cannot* tolerate thermal expansion at high speeds

Back-to-back mounting *cannot* accommodate shaft misalignment but *can* tolerate thermal expansion at high speeds

$$\omega_n = k^2 \sqrt{\frac{EI}{\rho L^4}}$$

$$F_{buckle} = \frac{cEI}{L^2}$$

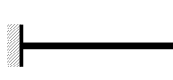
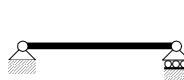
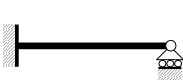
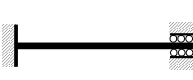
								
	Cantilevered		Simply Supported		Fixed-Simple		Fixed-Fixed	
mode n	k	c	k	c	k	c	k	c
1	1.875	2.47	3.142	9.87	3.927	20.2	4.730	39.5
2	4.694		6.283		7.069		7.853	
3	7.855		9.425		10.210		10.996	
4	10.996		12.566		13.352		14.137	
n	$(2n-1)\pi/2$		$n\pi$		$(4n+1)\pi/4$		$(2n+1)\pi/2$	

Symmetry

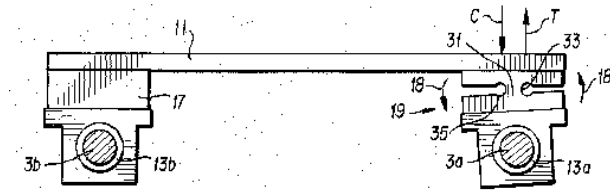
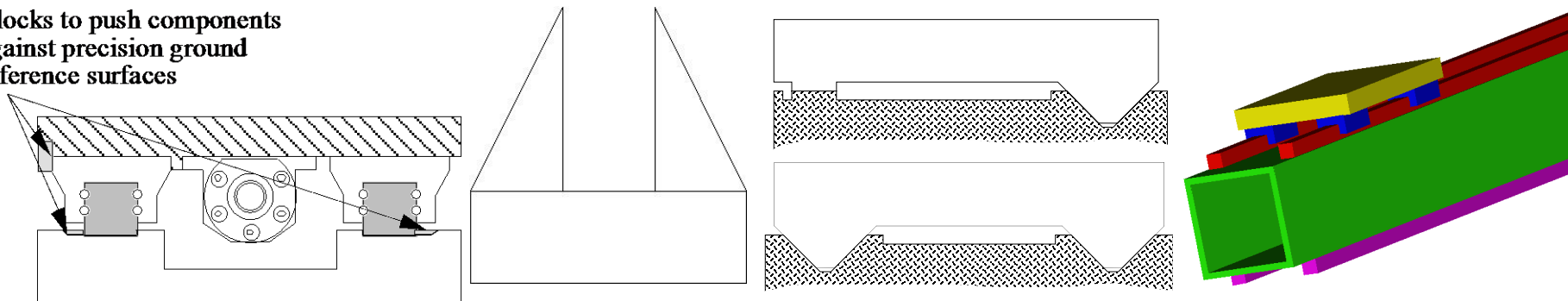

FIG. 3

- *Symmetry* can be a powerful design tool to minimize errors
 - Thermal gradient errors caused by bi-material structures can minimize warping errors
 - Steel rails can be attached to an aluminum structure on the plane of the neutral axis
 - Steel rails on an aluminum structure can be balanced by steel bolted to the opposite side
 - Angular error motions can be reduced by symmetric support of elements
- *Symmetry* can be detrimental (Maxwell applied to symmetry)
 - Differential temperature minimized by adding a heat source can cause the entire structure to heat up
 - Only attempt with extreme care
 - Better to isolate the heat source, temperature control it, use thermal breaks, and insulate the structure
 - A long shaft axially restrained by bearings at both ends can buckle
 - Remember-when you generalize, you are often wrong
 - The question to ask, therefore, is “Can symmetry help or hurt this design?”

Blocks to push components against precision ground reference surfaces



Accuracy, Repeatability, & Resolution

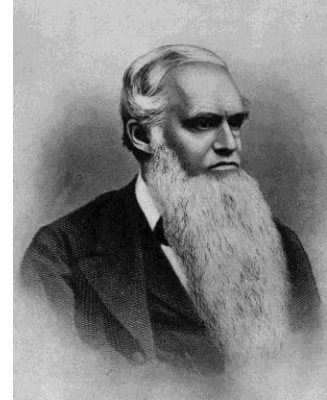

Joseph Brown

from J. Roe English and American Tool Builders, © 1916 Yale University Press

- Anything you design and manufacture is made from parts
 - Parts must have the desired accuracy, and their manufacture has to be repeatable
- **Accuracy:** the ability to tell the truth
 - Can two machines make exactly the same part?
 - Are the parts the exact size shown on the drawing?
- **Repeatability:** the ability to tell the same story each time
 - Can the machine make the exact same motion each time?
 - Are the parts all the same size?
- **Resolution:** the detail to which you tell a story
 - How fine can you adjust a machine?
 - How small a feature can you make?
- How do these affect the design process?

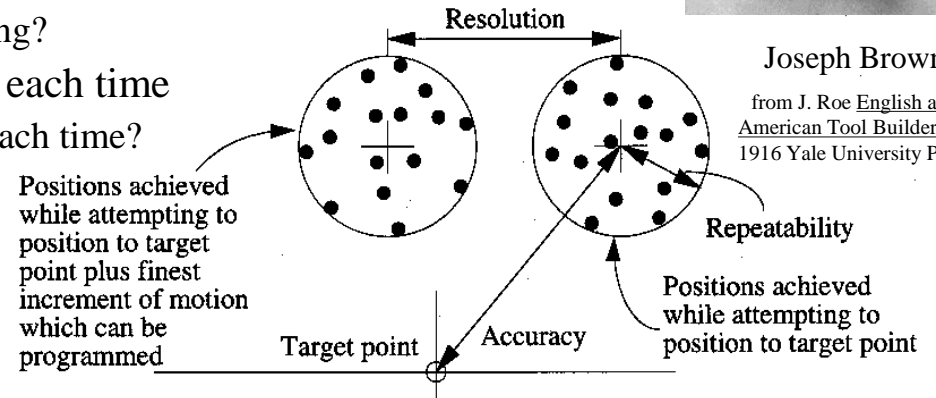

Hook launcher Model	
weight of hook (Kg)	0.05
muzzle velocity	9.4
Number of springs	2
d (draw)	0.095216
Winch model	
radius	0.05
mass	6
w (rpm)	55
torque	2.1
velocity	0.287833

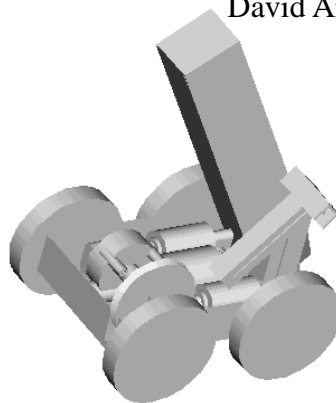
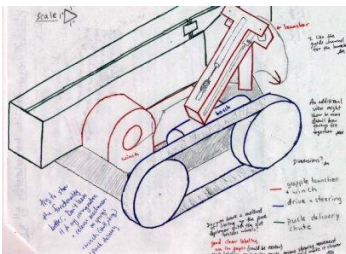

David Arguellis wins “MechEverest” with a machine that repeats every time!

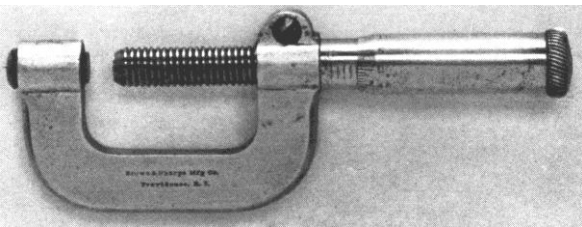
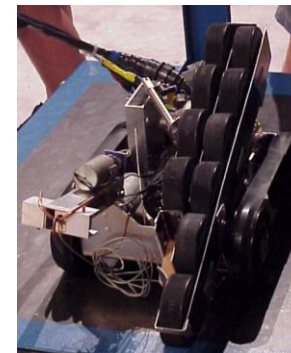

One-inch Micrometer (left) made by Brown & Sharpe, 1868 and Palmer Micrometer (right) brought from Paris by Brown in 1867 from J. Roe English and American Tool Builders, © 1916 Yale University Press

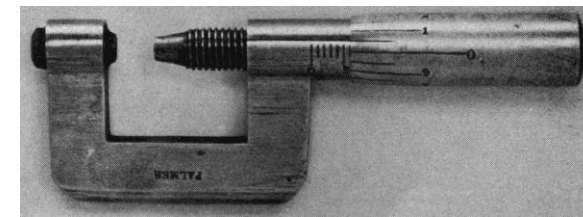

Accuracy, Repeatability, & Resolution: *Mapping*

- It is often most important to obtain mechanical *repeatability*, because *accuracy* can often be obtained by the sensor and control system
 - When the error motions of a machine are *mapped*, the controller multiplies the part height by the axis' pitch & roll to yield the sine error for which orthogonal axes must compensate



Eli Whitney

from J. Roe English and American Tool Builders, © 1916 Yale University Press

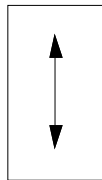

Y axis: Can be used to compensate for straightness errors in the X axis.



X axis: Can be used to compensate for straightness errors in the Y axis.

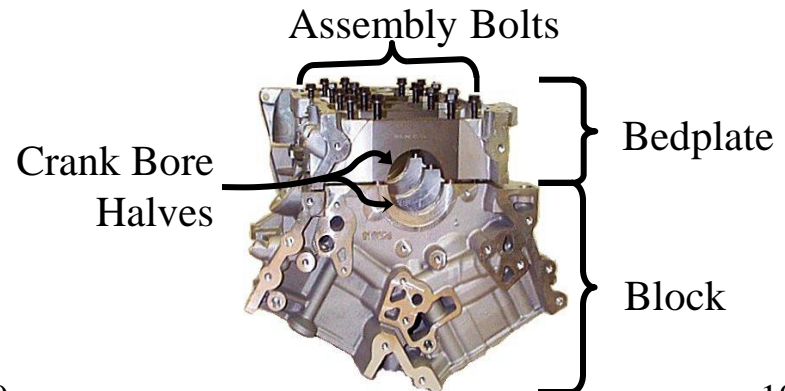
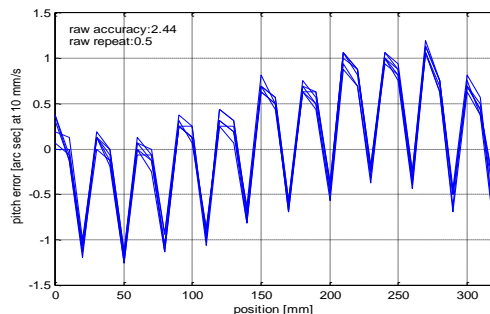
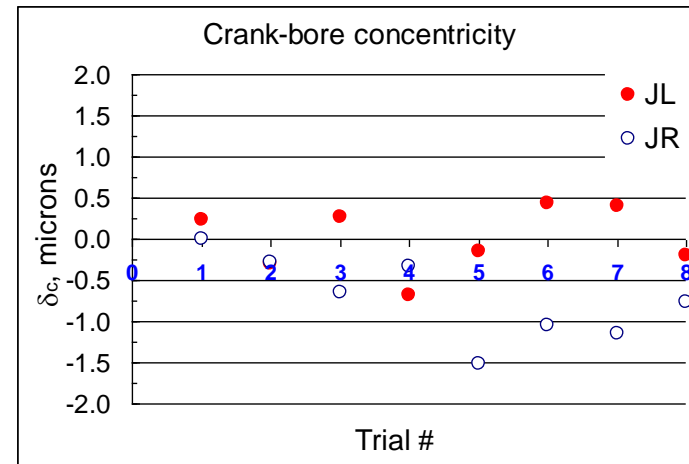

Sensitive Directions & Reference Features

- In addition to *accuracy*, *repeatability*, and *resolution*, we have to ask ourselves, “when is an error really important anyway?”
 - Put a lot of effort into accuracy for the directions in which you need it
 - The *Sensitive Directions*
 - Always be careful to think about where you need precision!

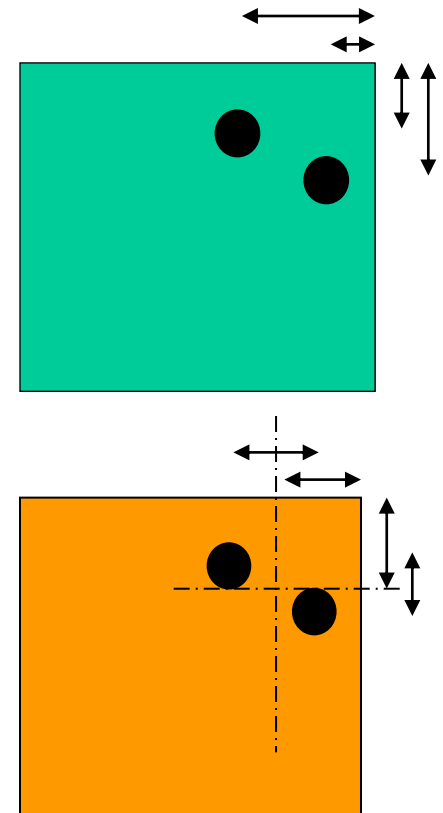
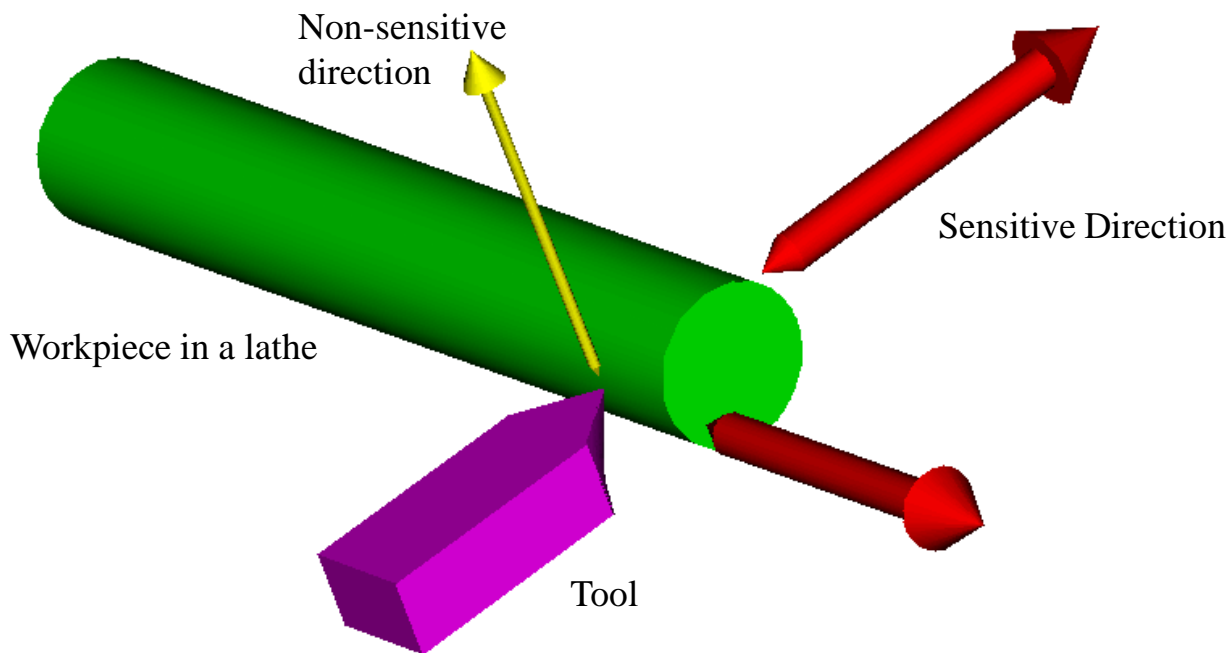

Structural Loops

- The *Structural Loop* is the path that a load takes from the tool to the work
 - It contains joints and structural elements that locate the tool with respect to the workpiece
 - It can be represented as a stick-figure to enable a design engineer to create a *concept*
 - Subtle differences can have a HUGE effect on the performance of a machine
 - The *structural loop* gives an indication of machine stiffness and accuracy
 - *The product of the length of the structural loop and the characteristic manufacturing and component accuracy (e.g., parts per million) is indicative of machine accuracy (ppm)*
 - Long-open *structural loops* have less stiffness and less accuracy

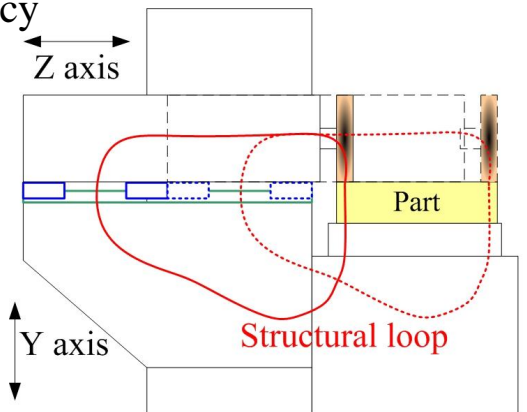
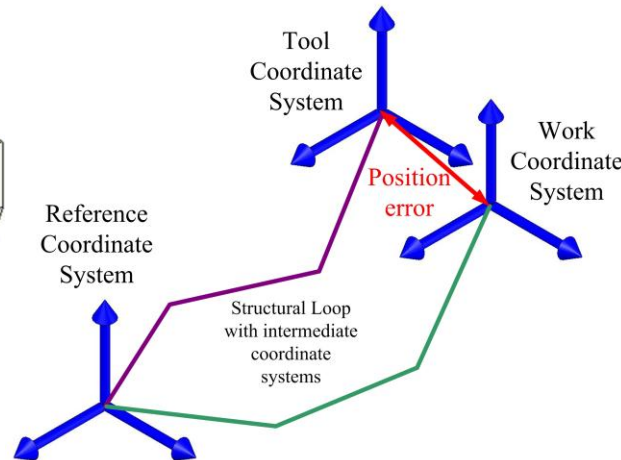
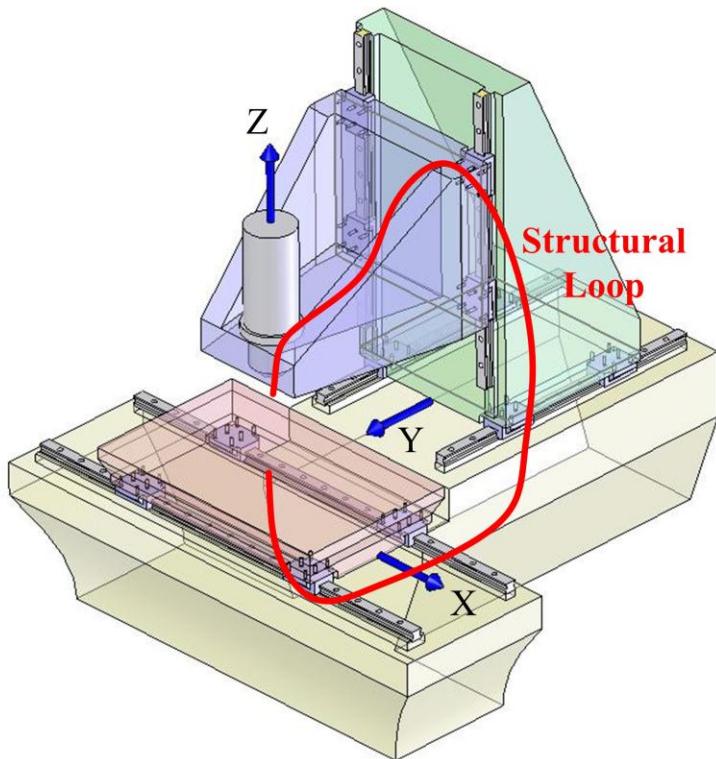

Constant Stiffness Design

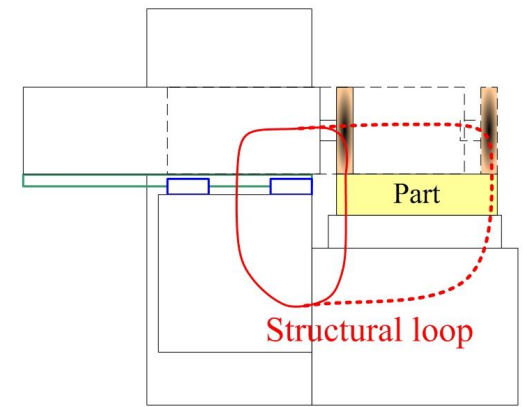

Maximum Stiffness Design

Preload

- Components that move relative to one another generally have tolerances that leave clearances between their mating features
 - These clearances result in *backlash* or wobble which is difficult to control
 - An example is the Lego roller coaster on page 3-10
- Because machine elements often have such small compliance, and to account for wear, backlash is often removed with the use of *preload*
 - Preload involves using a spring, or compliance in the mechanism itself, to force components together so there is no clearance between elements

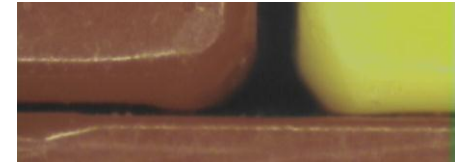

- However, the compliance in the preload method itself must be chosen such that it locally can deform to accommodate component errors without causing large increases in the forces between components
 - Linear and rotary bearings, gears, leadscrews, and ballscrews are often preloaded
 - » One must be careful when preloading to not too over constrain the system!
 - Structural joints are also often preloaded by bolts

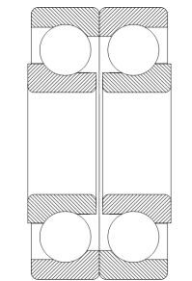

Bearings before mounting (inner ring axial clearance exaggerated)

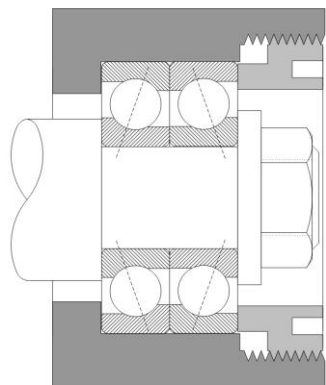

Back-to-back mounting after inner rings are clamped together

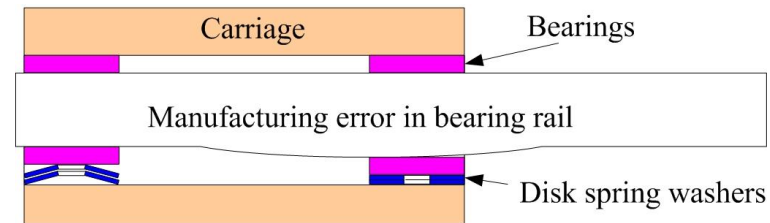
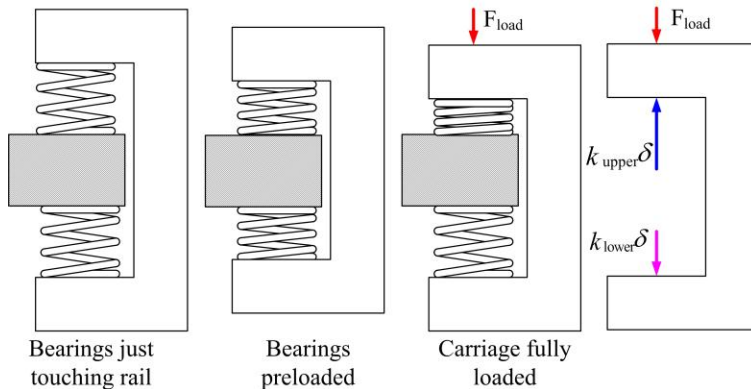

Load distribution on rolling elements due to radial load applied to bearings with various preload conditions

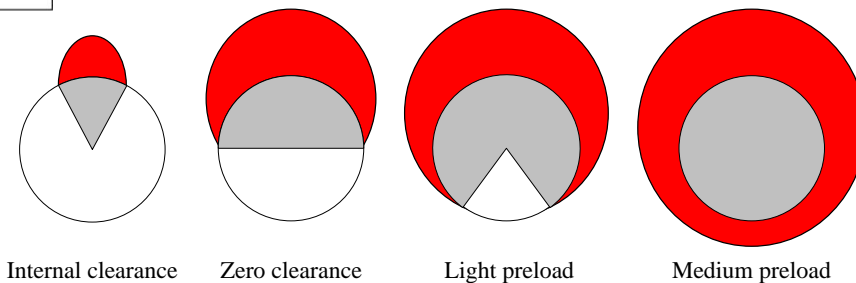

Centers-of-Action

- The *Centers-of-Action* are points at which when a force is applied, no moments are created:

- *Center-of-Mass*
- *Center-of-Stiffness*
- *Center-of-Friction*
- *Center-of-Thermal Expansion*

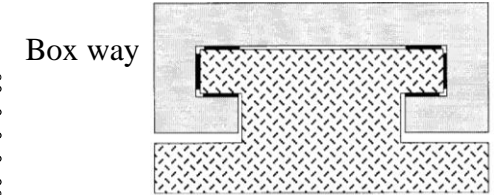
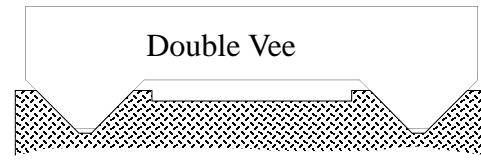
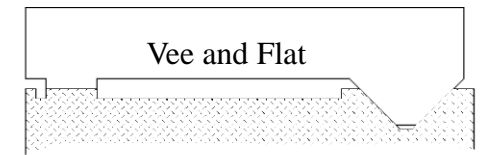
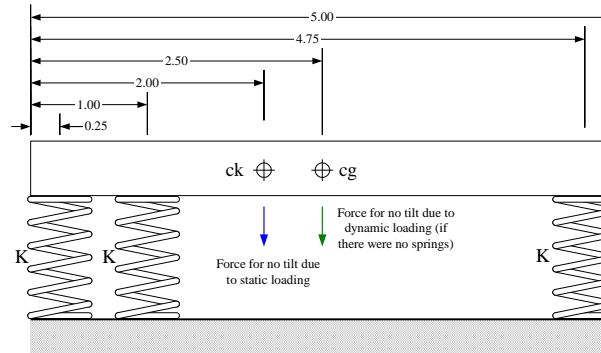

- A system is most robust when forces are applied as near as possible to the *Centers-of-Action*

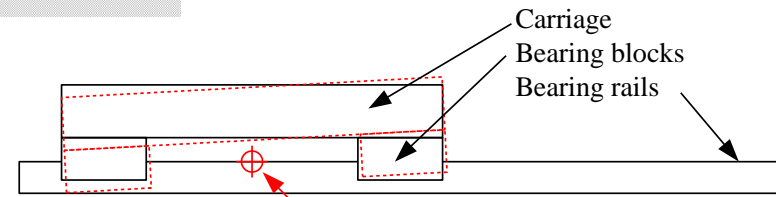
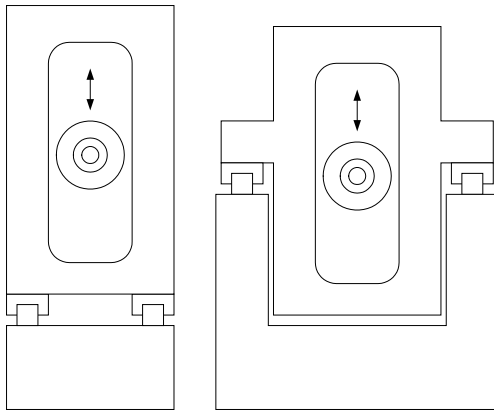
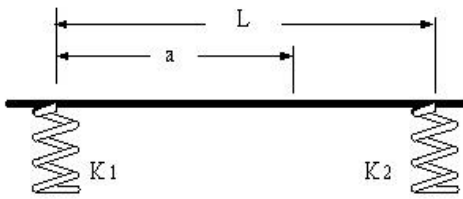

Funny image found on http://zeeb.at/oops/Nothing_Changes.jpg, photographer not credited, would like to, email slocum@mit.edu

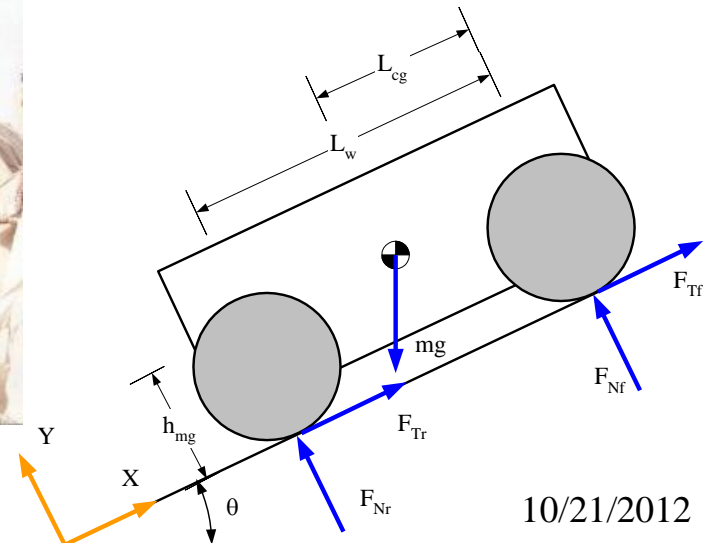

Exact Constraint Design

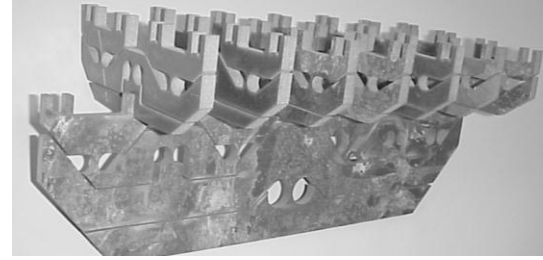

- Every rigid body has 6 *Degrees of Freedom* (DOF)
 - An exactly constrained design has no chance of deforming or having its function impaired by assembly, fastener tightening, thermal expansion, or external loads
- Make sure you have constrained what you want to constrain!
 - For a body to have N degrees of freedom free to move, there must be 6-N bearing reaction points!
 - To resist translation, a force is required.
 - To resist rotation, a moment, or two forces acting as a couple, is required!
- Saint-Venant rules! Do not constrain a shaft with more than 2 bearings, unless it is very long...

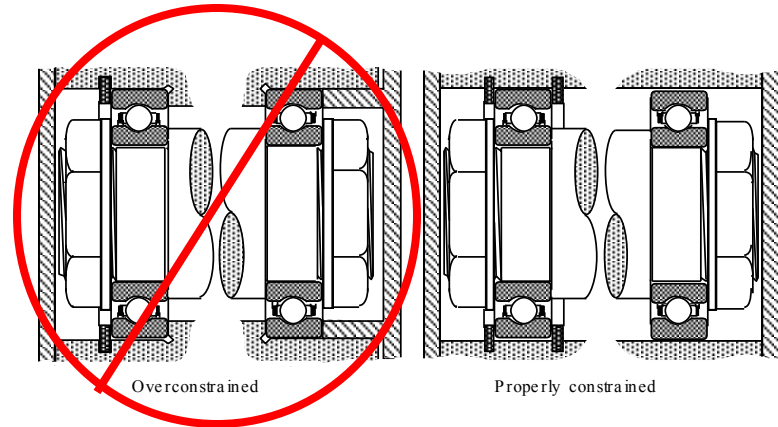
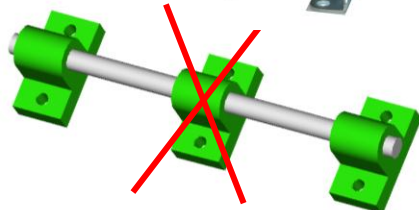
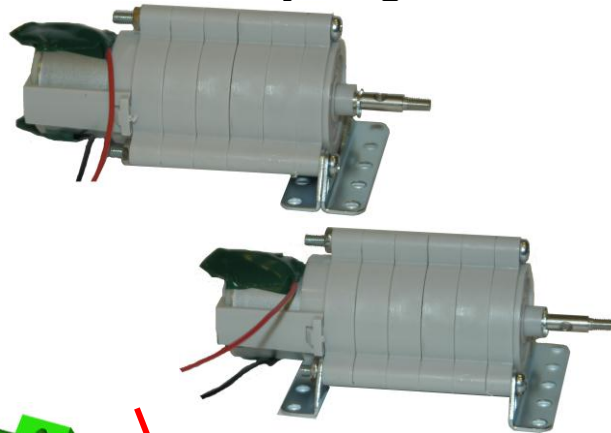
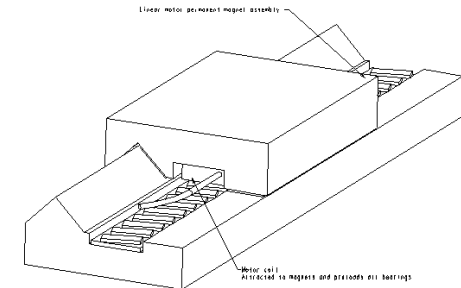
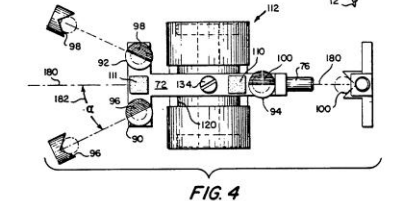
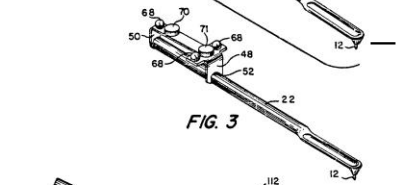
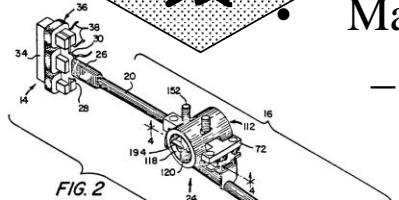
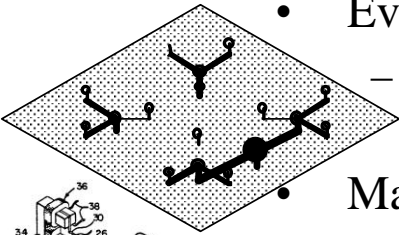

Elastically Averaged Design

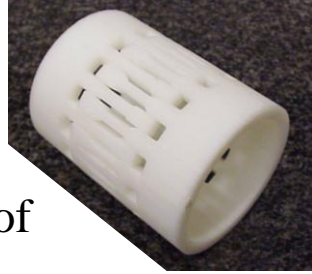

- Applying *Reciprocity to Exact Constraint Design* implies that instead of having an exact number of constraints, have an “infinite” number of constraints, so the error in any one will be averaged out!
 - Legos™, five legged chairs, windshield wipers, and Geckos are the most common examples, and many machine components achieve accuracy by elastic averaging

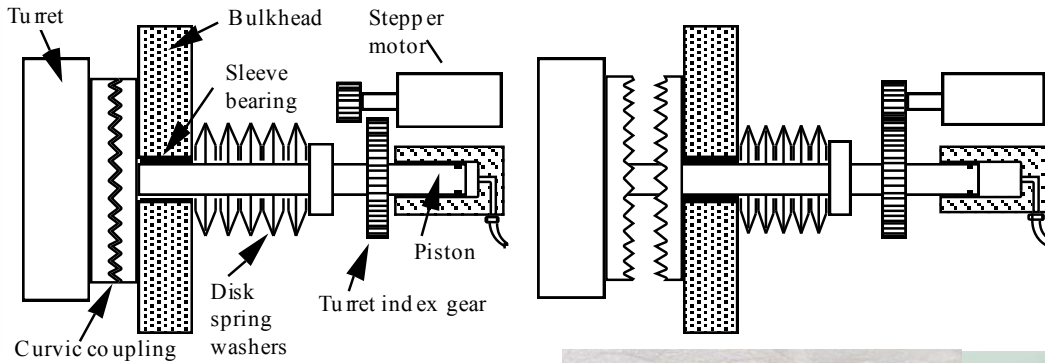
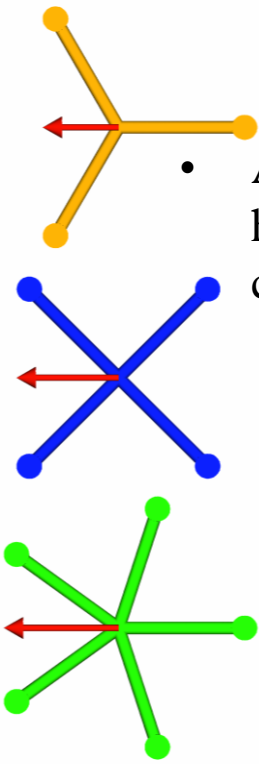

K. Autumn, Y. Liang, W.P. Chan, T. Hsieh, R. Fearing, T.W. Kenny, and R. Full, *Dry Adhesive Force of a Single Gecko Foot-Hair*, Nature. 405: 681-685 (2000)

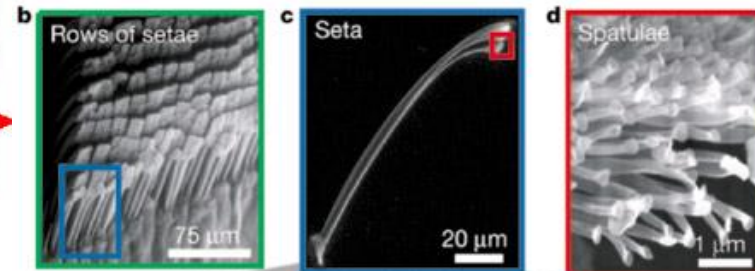
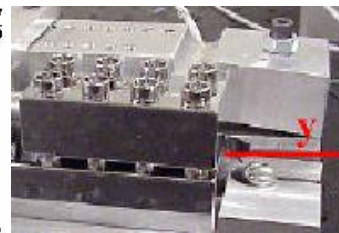
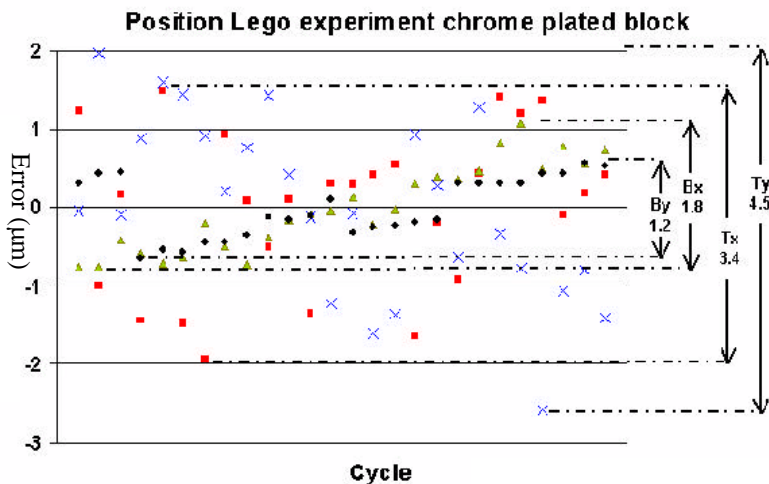

Stick Figures

- Use of *fundamental principles* allows a designer to sketch a machine and error motions and coordinate systems just in terms of a *stick figure*:
 - The sticks join at centers of stiffness, mass, friction, and help to:
 - Define the sensitive directions in a machine
 - Locate coordinate systems
 - Set the stage for error budgeting
 - The designer is no longer encumbered by cross section size or bearing size
 - It helps to prevent the designer from locking in too early
- Error budget and preliminary load analysis can then indicate the required stiffness/load capacity required for each “stick” and “joint”
 - Appropriate cross sections and bearings can then be deterministically selected
- It is a “backwards tasking” solution method that is very very powerful!

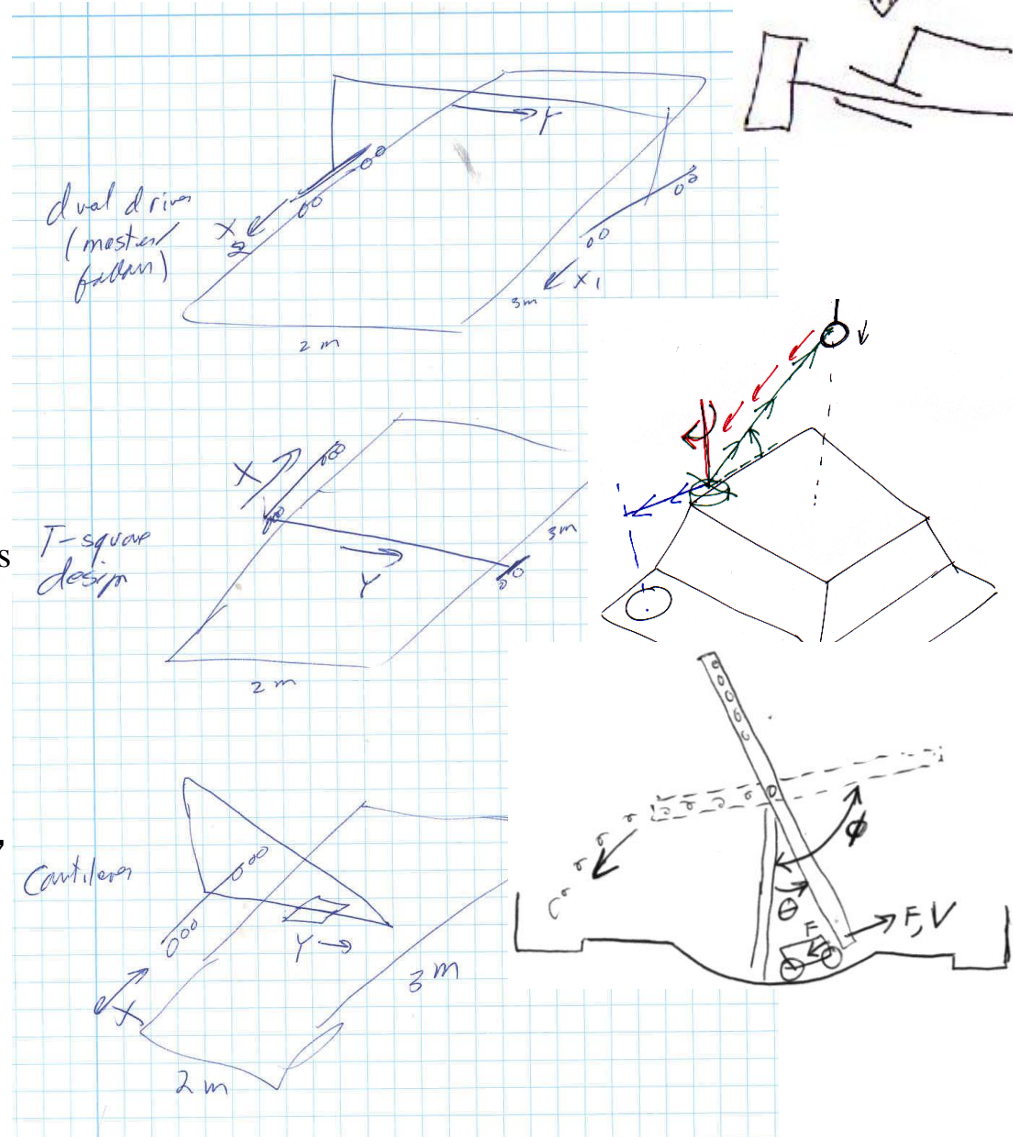

Mounting: *System Stiffness*

- Angular (tilt) stiffness can be estimated from lateral stiffness and bearing spacing
 - Angular misalignments are the most troublesome
 - Small misalignments can create very large bearing loads in stiff systems
- Springs modeling the system components are loaded by misalignment displacements
 - The resulting forces are added to the applied loads for life calculations

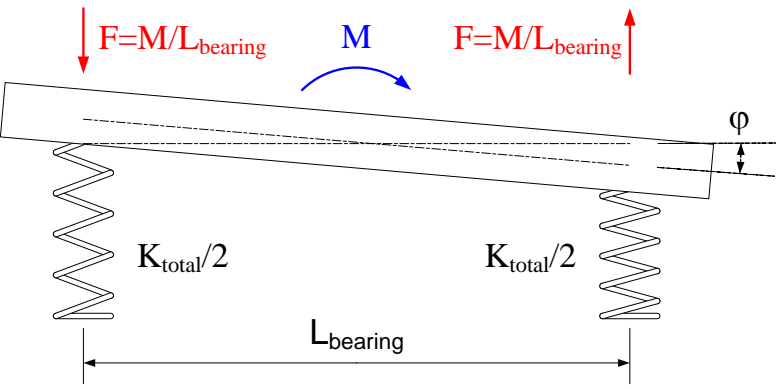
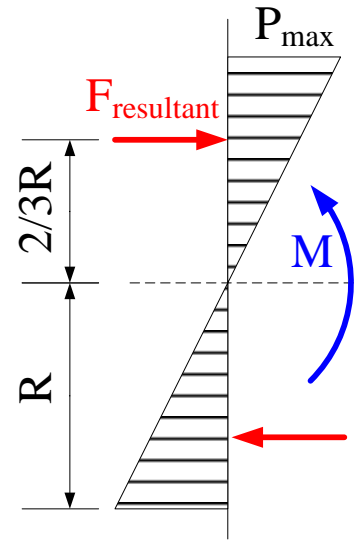

$$F = \frac{M}{L_{bearing}} \quad \delta = \frac{F}{k_{total}/2} = \frac{2M}{k_{total}L_{bearing}}$$

$$\phi = \frac{\delta}{L_{bearing}/2} = \frac{4M}{k_{total}L_{bearing}^2} \Rightarrow k_{angular} = \frac{k_{total}L_{bearing}^2}{4}$$

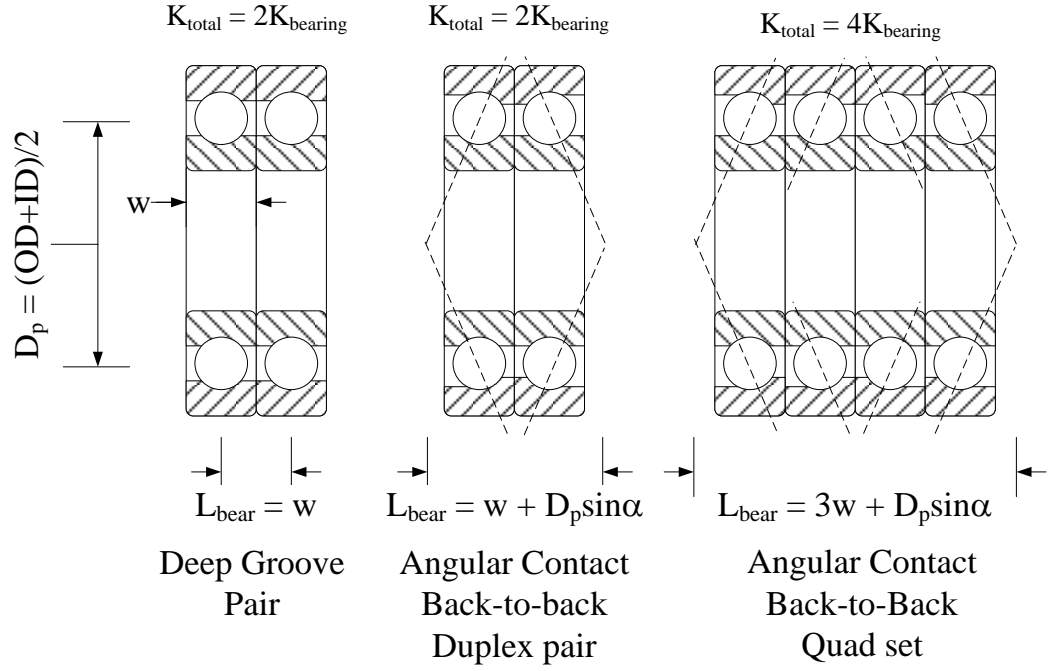

Mounting: *Stiffness by Finite Element Analysis*

- A system's stiffness can be accurately predicted using finite element analysis
 - The bearing elements are assigned a scaled modulus of elasticity so they have the spring constant provided by the catalog
 - This enables a solid model of the machine to be built and then analyzed without having to add linear spring elements at nodes
 - This also captures the angular stiffness of the bearing

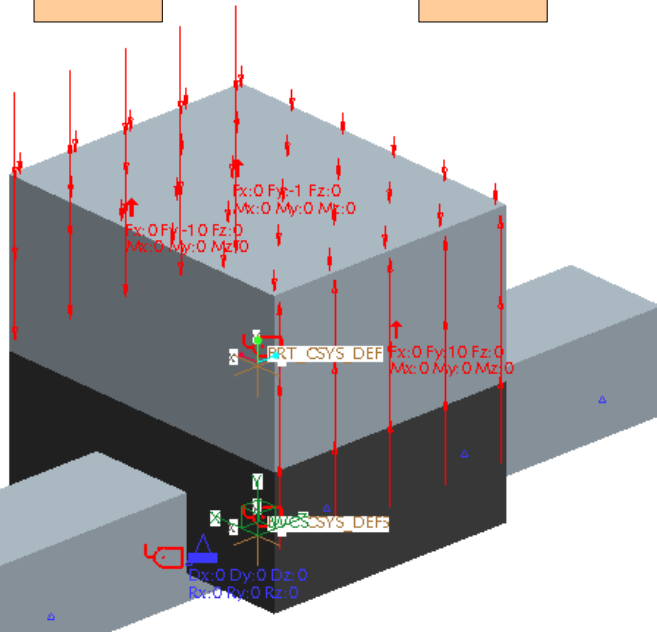
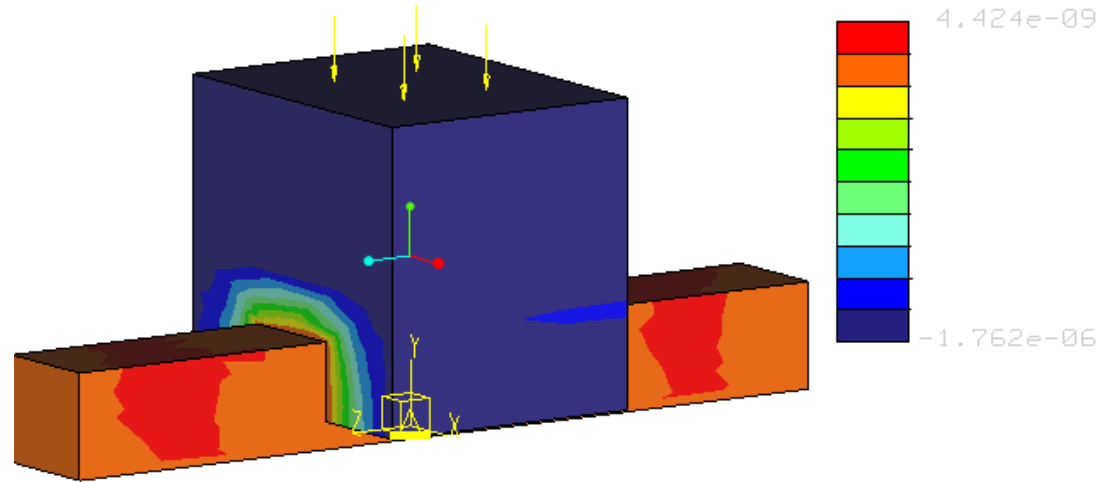
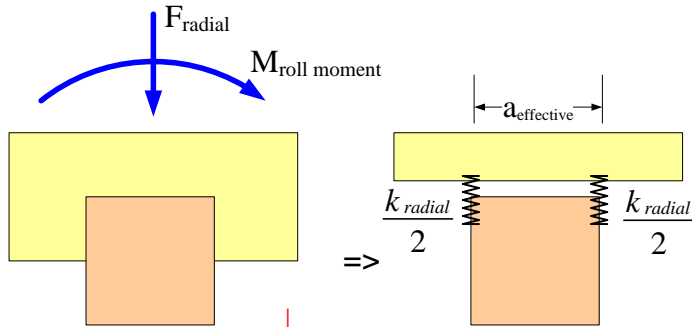

Applied load (N) F	1			
Catalog stiffness (N/micron) Kcat	578			
Deflection (mm) dcat	1.73E-06			
	Initial est	1st pass	2nd pass	Final
Bearing block modulus (N/mm ²)	10000	2404	1972	1915
FEA predicted deflection (mm) dfea	4.16E-07	1.42E-06	1.68E-06	1.73E-06
FEA predicted stiffness (N/micron)	2404	705	595	578
Scale factor required (dcat/dfea)	4.16	1.22	1.03	

Mounting: *Misalignment*

Radial and angular misalignment errors can be major contributors to total bearing loading!

– Springs-in-series models can be used to determine bearing loads caused by misalignment displacements, ala $F = k\delta$

• See the spreadsheet:

– *Bearing_stiffness_alignment.xls*

Case 1, simply supported beam (typically $N_{bear} = N_{bear2} = 1$)	
Resulting moment, $M_{resultss}$ (N-m)	0.360
Resulting radial forces due to misalignment	
First bearing set (N)	30
Second bearing set	30
Case 2, beam ends guided (zero slope) with bearing angular compliance	
Resulting moment, $M_{resultbeg}$ (N-m)	0.529
Resulting radial forces due to misalignment	
First bearing set (N)	44
Second bearing set	44
Case 3, beam ends guided (zero slope) with no bearing angular compliance	
Resulting moment, $M_{resultberg}$ (N-m)	12.0
Resulting radial forces due to misalignment	
First bearing set (N)	997
Second bearing set	997

Misalignment (displacement) delta only	
Both ends guided	
Force at ends, F (N)	40.6
Moment at ends, M (N-mm)	2031
Stress at ends (N/mm ²)	20.7
Cantilevered	
Force at ends, F_c (N)	10.2
Moment at base, M_c (N-mm)	1015
Stress at base (N/mm ²)	10.3

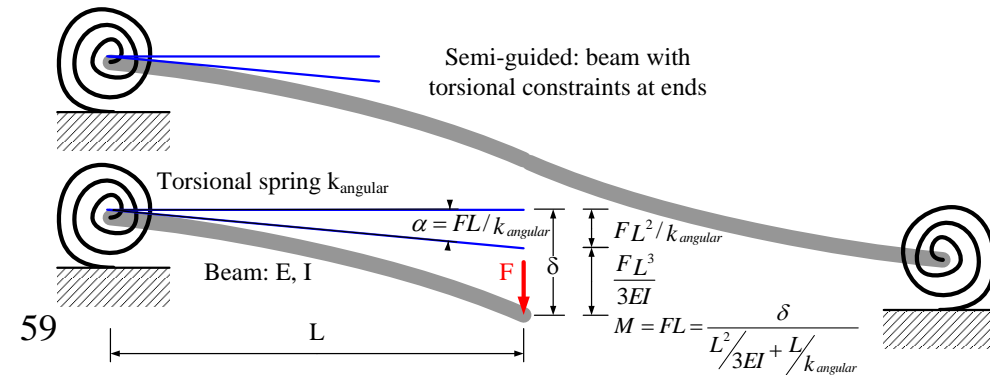
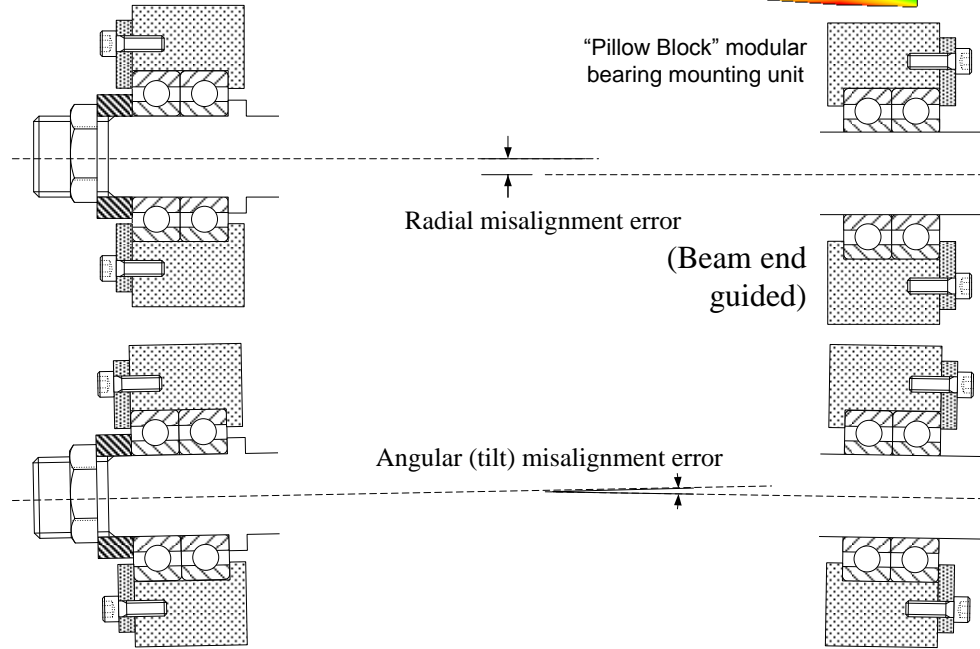
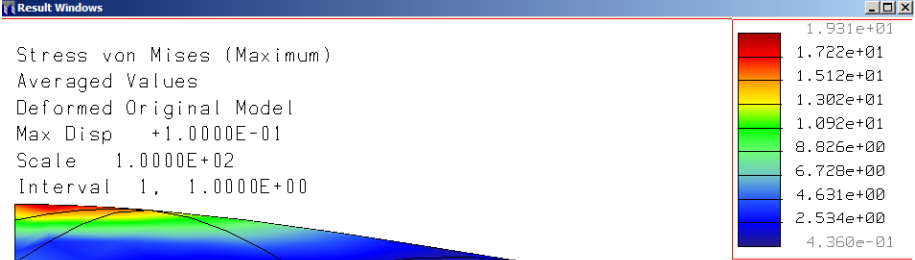

Mounting: *Centers of Action*

- A body behaves as if all its mass is concentrated at its *center of mass*
- A body supported by bearings, acts about its *center of stiffness* (there can be several in an axis...)
 - The point at which when a force is applied to an axis, no angular motion occurs
 - The point about which angular motion occurs when forces are applied elsewhere
 - Found using a center-of-mass type of calculation (K is substituted for M)

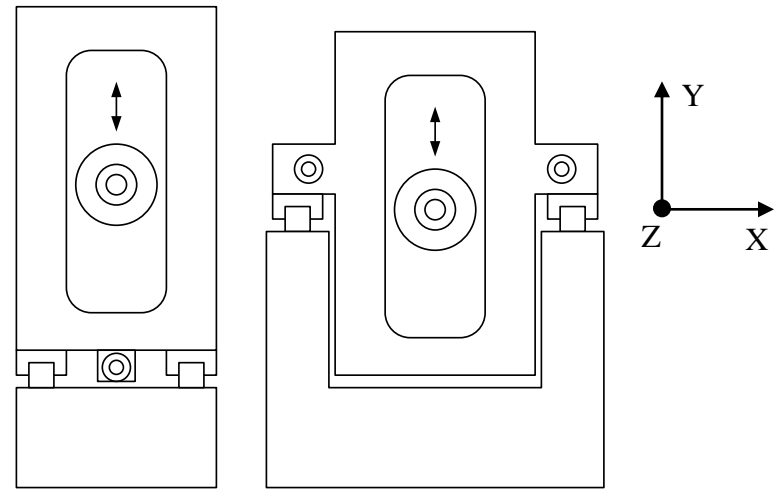
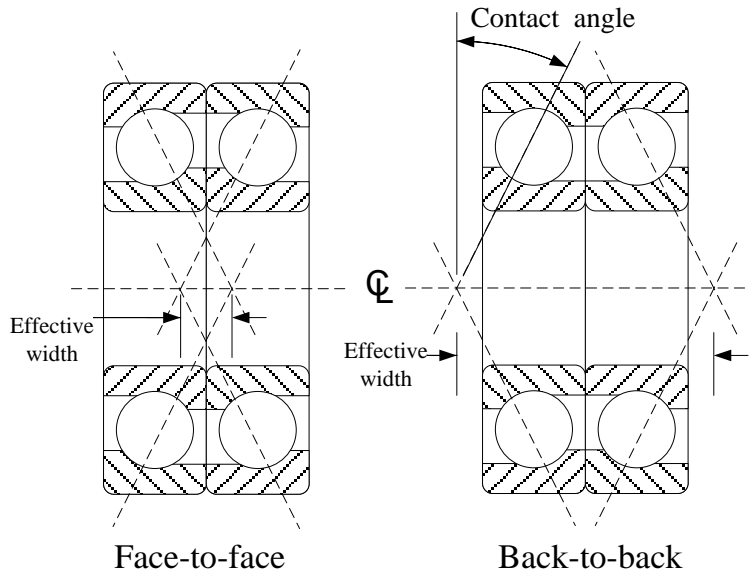
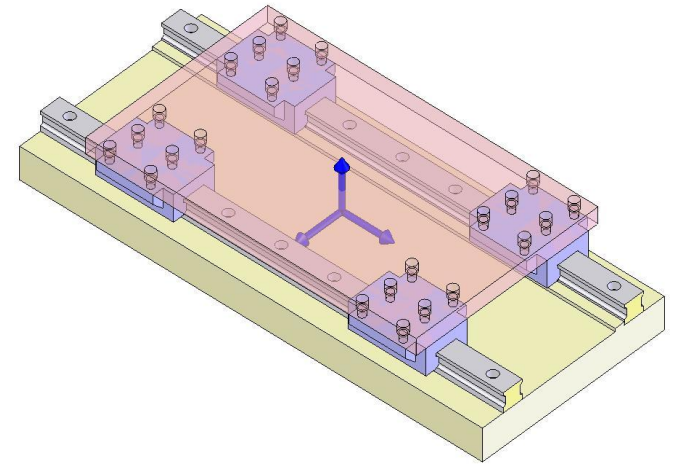
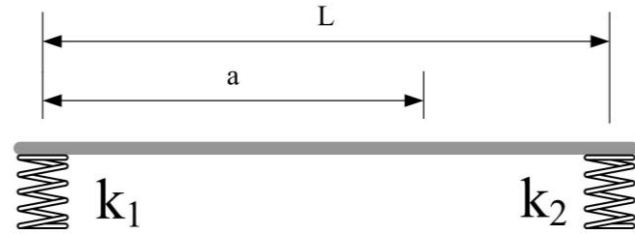
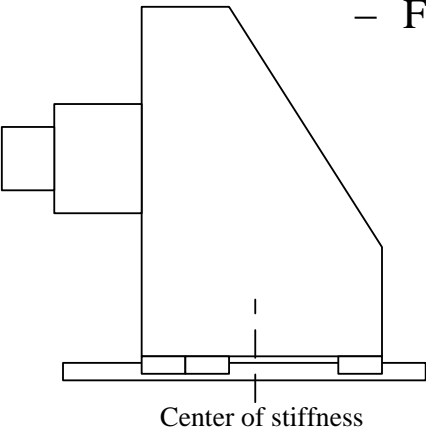

Mounting: *Saint-Venant*

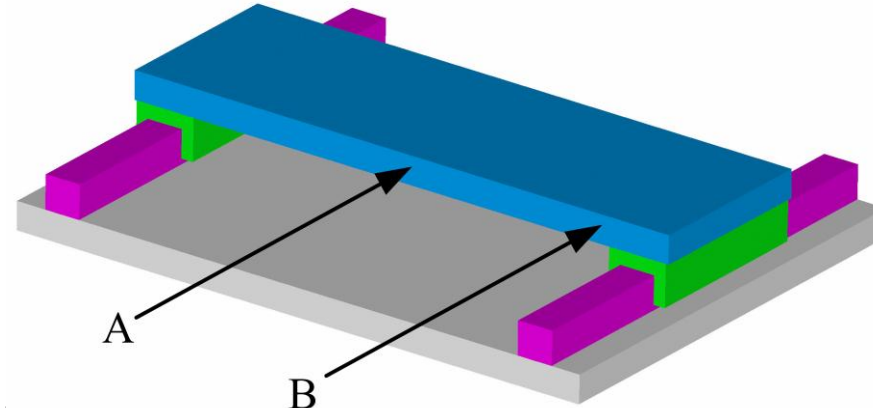
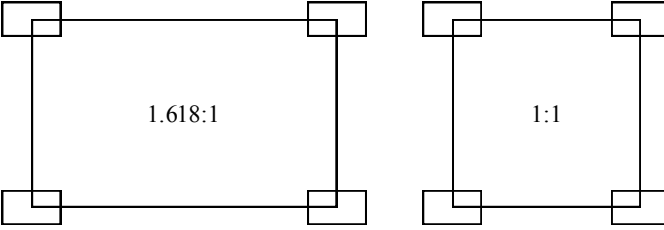
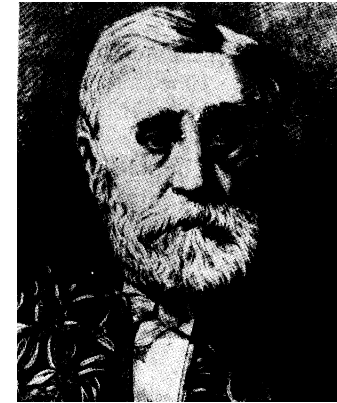

- St. Venant: Linear Bearings:
 - $L/D > 1$
 - 1.6:1 very good
 - 3:1 as good as it gets

- St. Venant: Rotary Bearings:
 - $L_{\text{shaft}}/L_{\text{bearing spacing}} < 1$ and the shaft can be cammed over
 - $L_{\text{shaft}}/L_{\text{bearing spacing}} > 3-5$ and the slope from shaft bending might overload the bearings, so provide adequate clearance
 - A shaft should not have to bend to remove all clearance between it and the bearing bore!

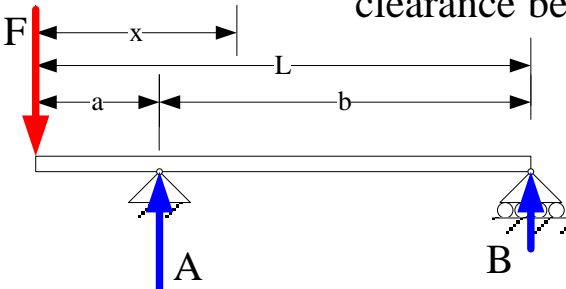

See *Bearings_slightly_supported_shaft.xls* to determine if shaft deflection will edge load bearings

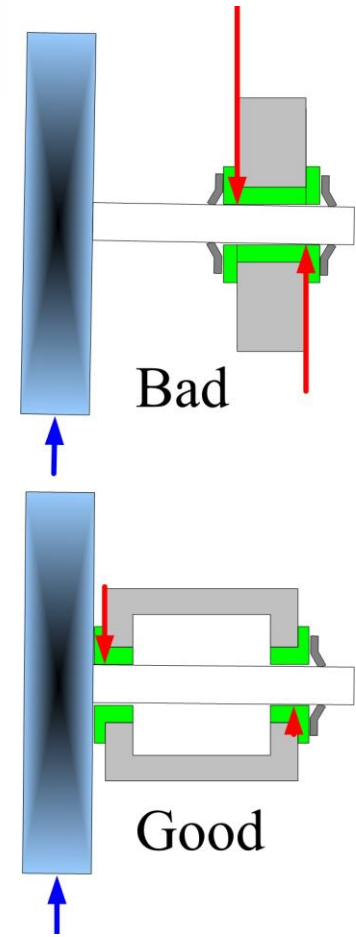
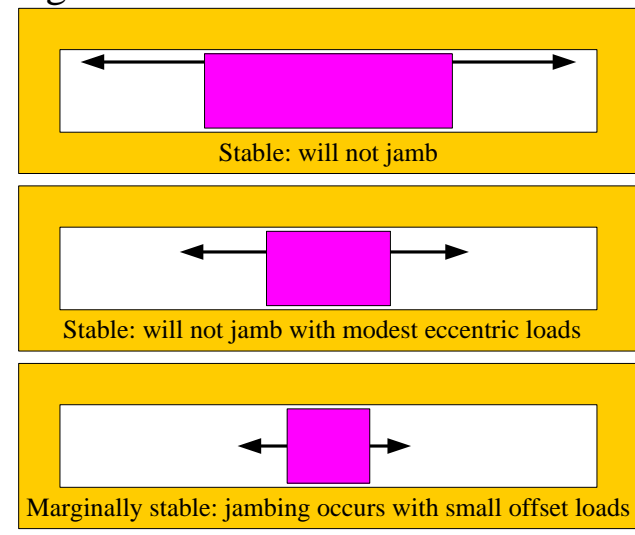
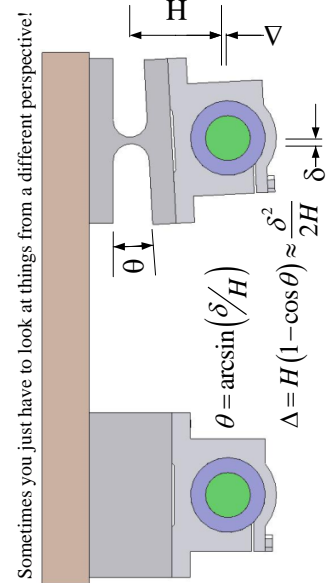
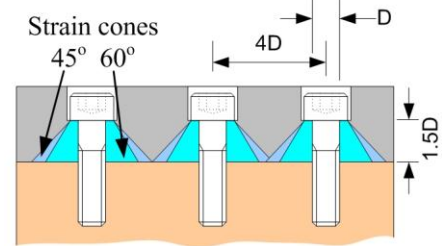

Mounting: *Rotary Motion*

- Every rotary motion axis has one large degree of freedom, and five small error motions
- 5 degrees of freedom are typically constrained with one thrust bearing and two radial bearings
 - Axial constraint obtained by use of e-clip, push nut, snap-ring, threaded nut, or shoulder

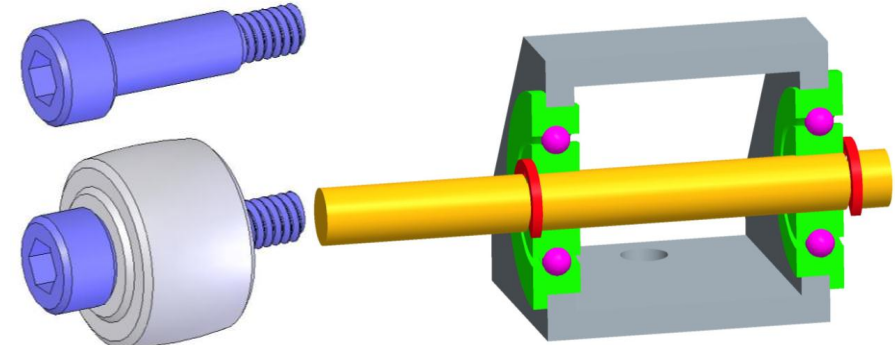
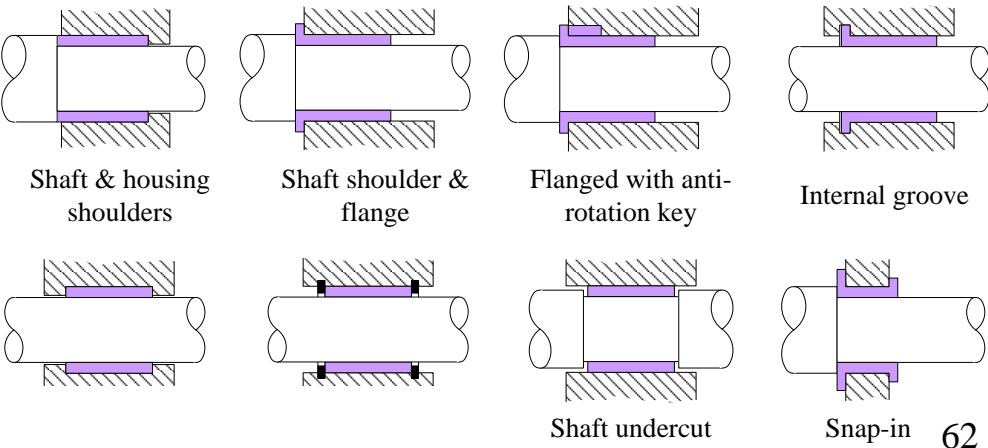
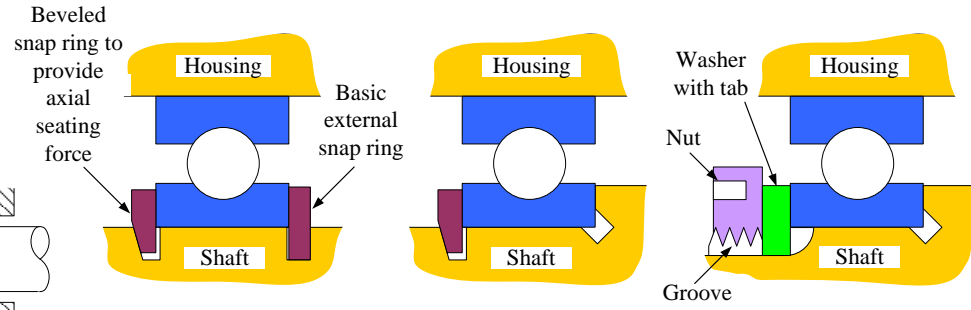
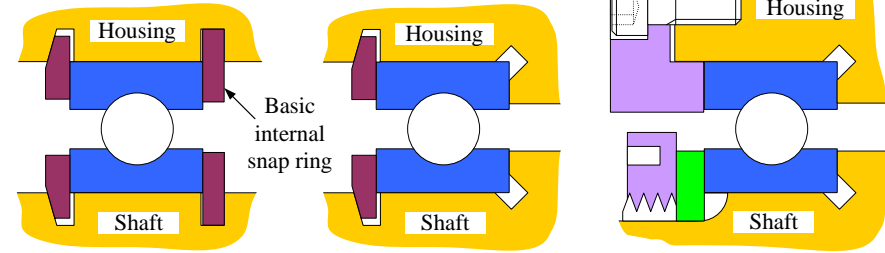
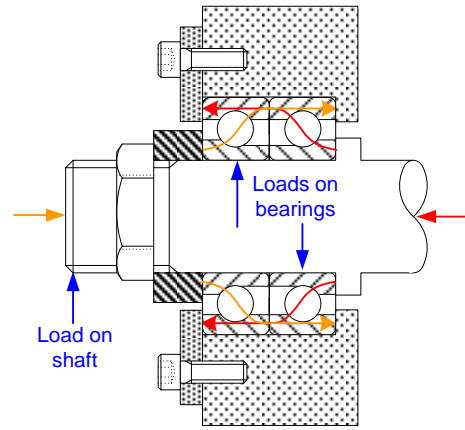

Mounting: "Ball Bearings"

- *Ball bearings' inner races* are mounted on a *shaft*, and the *outer races* fit in a *bore*
 - All bearings generate heat when they rotate
 - Thermal growth can cause overconstraint and overloading
 - A spindle's rotating shaft gets hotter faster than the housing
 - Back-to-back mounting balances radial and axial thermal expansion to maintain constant preload (*thermocentric* design)
- Multiple bearings can be used to achieve required load capacity & stiffness
- Angular contact bearings can be mounted in a *thermocentric* configuration
- Deep groove bearings can be mounted with one fixed and one floating to achieve good low speed performance ($DN < 1000$)

Angular contact ball bearing spindle with integral frameless brushless DC motor

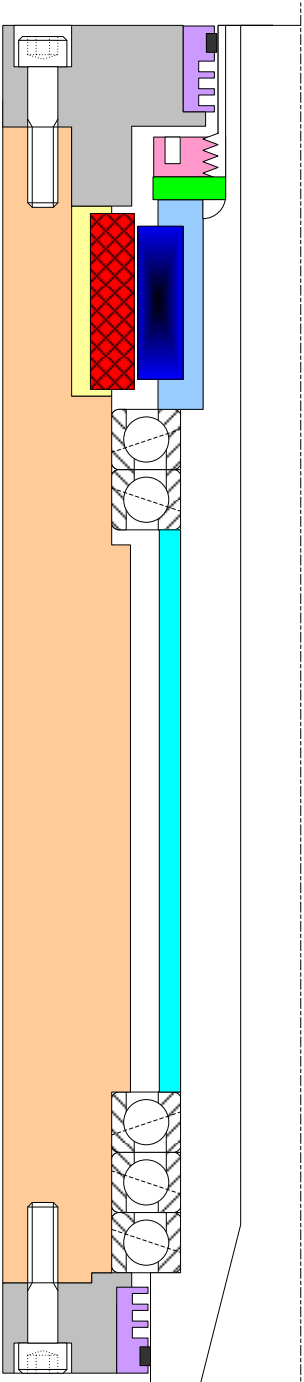

Thermocentric configuration

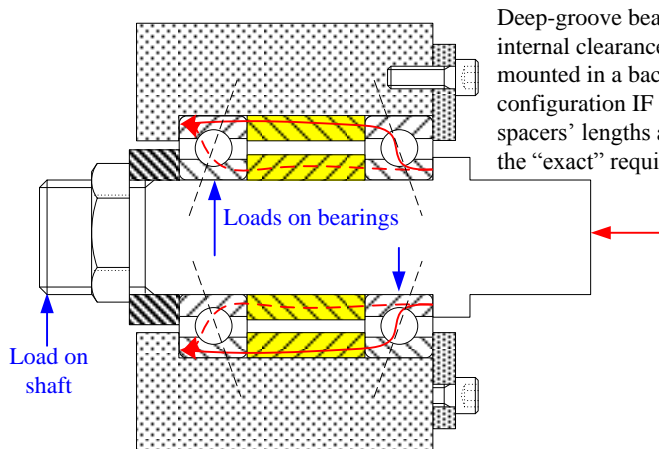

Back-to-back preload:
axial load capacity = axial load capacity of one bearing
axial Stiffness = 2 X axial stiffness of one bearing

Floating configuration

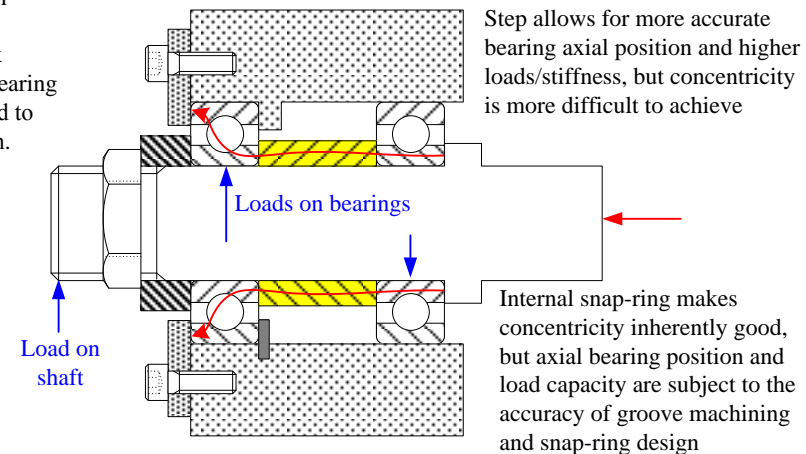

Deep-groove preload by oversize balls
axial load capacity = axial load capacity of one bearing
axial Stiffness = 2 X axial stiffness of one bearing

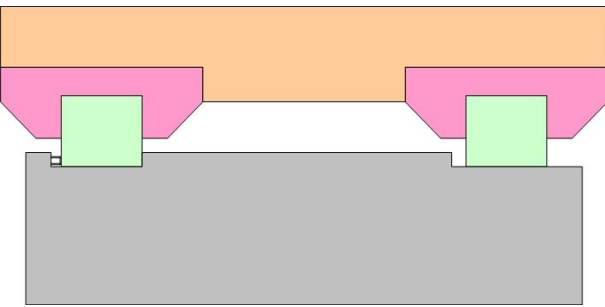

Mounting: *Linear Motion*

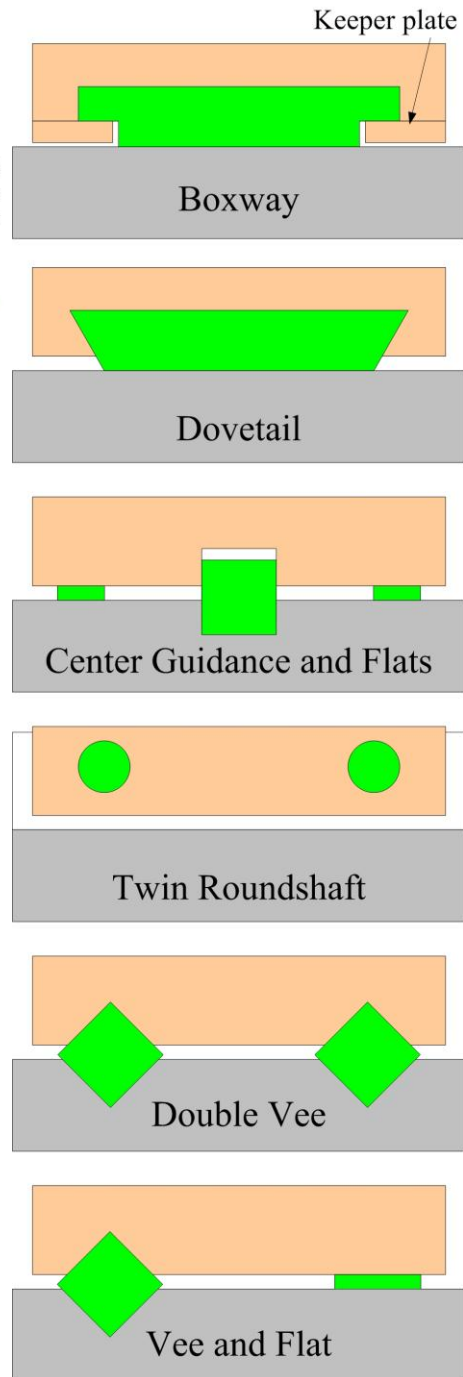
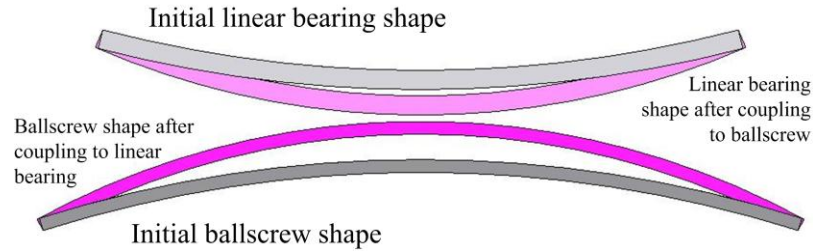

- Linear motion axes usually have one large degree of freedom, 5 degrees of freedom constrained, and five small error motions
 - Typical preloaded machine tool carriages have pairs of preloaded bearing pads in vertical and horizontal directions at each of 4 corners

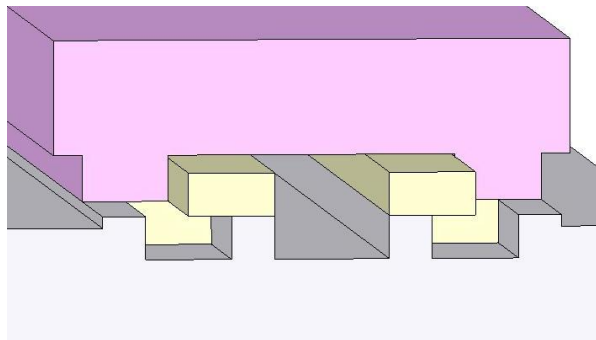
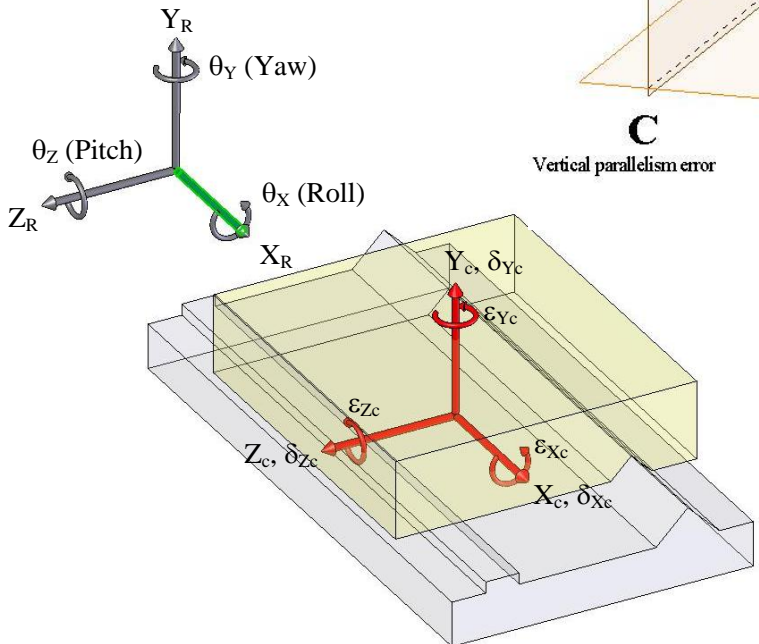
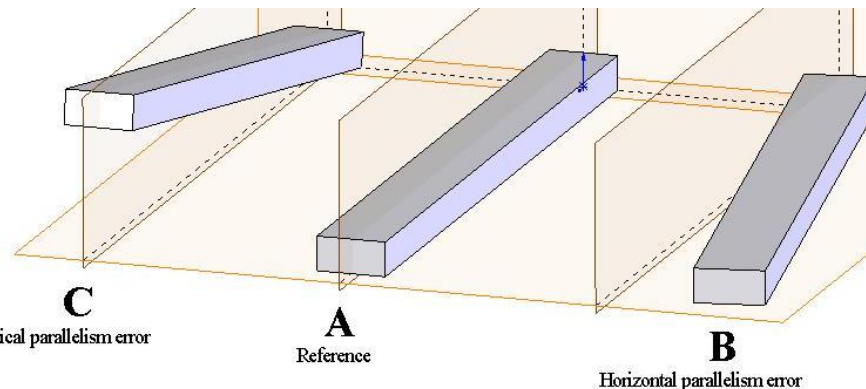

Example: Multiple Linear Guide Carriages

- Four bearing carriages supporting an axis are common
- What if there are very large loads focused on one end of the carriage?
 - E.g., overhanging load
- Will adding a 3rd set of carriages help?
 - Will the added carriages too fight each other and reduce life?

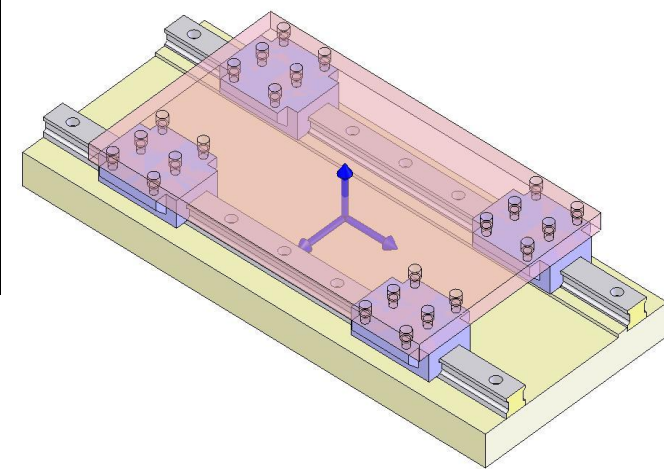
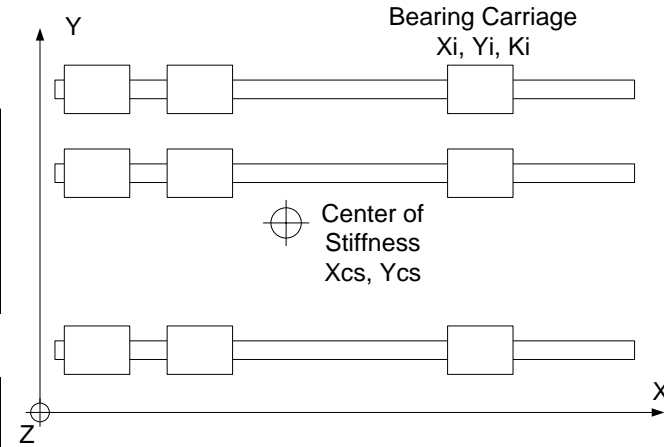

<i>Bearings_linear_carriages.xls</i>				
To determine forces on each of 4 learn bearing carriages centered about a coordinate system				
Written by Alex Slocum. Last modified 10/9/2006 by Alex Slocum				
Enters numbers in BOLD , Results in RED . NOTE: BE CONSISTENT WITH UNITS				
Assumes supported structure is much stiffer than bearing carriages, and misalignment loads are conservatively estimated to be product bearing carriage stiffness (N/micron) and misalignment (microns)				
Location of center of stiffness				
Xcs	0			
Ycs	0	Stiffness contribution from rows		
Actuator stiffness Kxact (assume actuator placed at Ycs) (N/micron)	1000	Row 1	Row 2	Row 3
Net Y radial stiffness Ky _{cs} (N/micron)	4000	2000	0	2000
Net Z radial stiffness Kz _{cs} (N/micron)	4000	2000	0	2000
Net roll (K _{θX}) stiffness Kroll (N-m/microrad)	4000	2000	0	2000
Net pitch (K _{θY}) stiffness Kpitch (N-m/microrad)	4000	2000	0	2000
Net yaw (K _{qZ}) stiffness Kyaw (N-m/microrad)	2828	1414	0	1414
Resultant forces and moments at center of stiffness		Resultant deflections at center of stiffness		
F _x (N)	0	dx _{cs} (micron)	0.000	
F _y (N)	0	dy _{cs} (micron)	0.000	
F _z (N)	100	dz _{cs} (micron)	0.025	

Example: Ballscrew Nut Coupling to a Linear Motion Carriage

- In a design review, you see a very large diameter ballscrew bolted to a very stiff carriage supported by 4 linear guide bearings
- The team wonders should they mount the ballscrew nut near the center or at the end of the carriage?
- During coffee break, you sketch the two options and attach preliminary calculations:
- Parameters:
 - Kradial bearing block = 1000 N/micron
 - Kradial ballscrew bearing support block = 1000 N/micron
 - Lballscrew = 2000 mm
 - Dballscrew = 75 mm
 - Dmisalignment = 5 microns
- What is the maximum potential misalignment load applied to the bearing blocks?
- What are the maximum potential error motions in the carriage?

